



Collars, Bands & Grooved bars

**CA-086 GR / 12x3**

(2 bars of 12x6)

**CA-087 GR / 12x3**

(3 bars of 12x6)

**CA-088 GR / 12x3**

(4 bars of 12x6 or 2 bars of 12)

**CA-089 GR / 12x3**

(2 bars of 10x10)

**CA-090 GR / 12x3**

(1 bar of 25x25)

**CA-091 GR / 20x4**

(1 bar of 30x30)

**CA-092 GR / 20x4**

(2 bars of 12x12)

**CA-093 GR / 12x3**

(3 bars of 12x12 Collar for P-505)

**CA-094 GR / 20x4**

(3 bars of 20x8 Collar for P-503)

**CA-095 GR / 20x4**

(1 bar of 20x20 Collar for P-5708)

**CA-096 GR / 20x4**

(1 bar of 25x25)

**CA-097 GR / 12x3**

(2 bars of 14x16)

**CA-098 GR / 12x3**

(1 bar of 14x14)

**CA-099 GR / 12x3**

(1 bar of 16x16)

**CA-100 GR / 25x4**

(1 bar of 30x30)

**CA-101 GR / 12x3**

(1 bar for 14+2 bars of 14x6)

**CA-102 GR / 12x3**

(3 bars for 8x8 Rosette)

**CA-103 GR / 12x3**

(2 bars for 8x8 Rosette)



RL-026 - 14x4

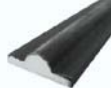

RL-027 - 18x5

Strips for Collars and Grooved HM bars

**GR-026** 12 x 3 (3mt./10ft.)

(0.848 kg.-1.869 lbs.) 1side12

**GR-026/a** 12 x 3 (4mt./13ft.)

(1.130 kg.-2.491 lbs.) 1side12

**GR-027/a** 14 x 6 (4mt./13ft.)

(2.637 kg.-5.812 lbs.) 2sides6

**GR-028** 12 x 12 (3mt./10ft.)

(3.390 kg.-7.472 lbs.)

**GR-029** 8 x 8 (3mt./10ft.)

(1.510 kg.-3.328 lbs.)

**GR-030** 20 x 8 (3mt./10ft.)

(3.780 kg.-8.331 lbs.) sides 8

**GR-030/a** 16 x 8 (3mt./10ft.)

(3.010 kg.-6.634 lbs.)

**GR-031** 20 x 4 (3mt./10ft.)

(1.885 kg.-4.155 lbs.) 1 face 20

**GR-031/a** 20 x 4 (3mt./10ft.)

(1.884 kg.-4.159 lbs.) 1 face of 20

**CA-086 HR / 13X3**

(2 bars of 12x6 or 1 bar of 12)

**CA-087 HR / 13X3**

(3 bars of 12x6 or equivalent)

**CA-088 HR / 13X3**

(4 bars of 12x6 or 2 bars of 12)

**CA-089 HR / 13X3**

(2 bars of 10x10)

**CA-090 HR / 13X3**

1 bar of 25x25

**CA-091 HR / 13X3**

1 bar of 30x30

**CA-092 HR / 13X3**

(2 bars of 14x6 or equivalent)

**CA-093 HR / 13X3**

(3 bars of 12x12)

**CA-094 HR / 13X3**

(3 bars of 20x8)

**CA-095 HR / 13X3**

(1 bar of 20x20)

**CA-096 HR / 13X3**

(1 bar of 25x25)

**CA-097 HR / 13x3**

(2 bars of 14x16)

**CA-098 HR / 13x3**

(1 bar of 14x14)

**CA-099 HR / 13x3**

(1 bar of 16x16)

**HR-026** 13 x 3 (3mt./10ft.)

(0.848 kg.-1.869 lbs.) 1side13

**HR-026/a** 13 x 3 (4mt./13ft.)

(1.130 kg.-2.491 lbs.) 1side13

**RL-026** 14 x 4 (3mt./10ft.)

(1.480 kg. - 3.262 lbs.)

**RL-027** 18 x 5 (3mt./10ft.)

(1.710 kg. - 3.768 lbs.)



**GR-032** 20 x 6 (3mt./10ft.)

(2.826 kg.-6.229 lbs.) sides of 6

**GR-033** 25 x 4 (3mt./10ft.)

(2.355 kg.-5.190 lbs.) 1 face 25

**GR-033/a** 25 x 4 (3mt./10ft.)

(2.355 kg.-5.199 lbs.) 1 face of 25

**GRHM-009** 12 x 6 (3mt./10ft.)

(1.695 kg.-3.742 lbs.) 2 sides of 6

**GRHM-014** 16 x 8 (3mt./10ft.)

(3.010 kg.-6.646 lbs.) 2 sides of 8

**GRHM-003** 12 x 12 (3mt./10ft.)

(3.390 kg.-7.485 lbs.) 2 sides of 12

**GRHM-005** 16 x 16 (3mt./10ft.)

(6.028 kg.-13.311 lbs.) 2 sides of 16

**GRHM-006** 20 x 20 (3mt./10ft.)

(9.420 kg.-20.799 lbs.) 2 sides of 20

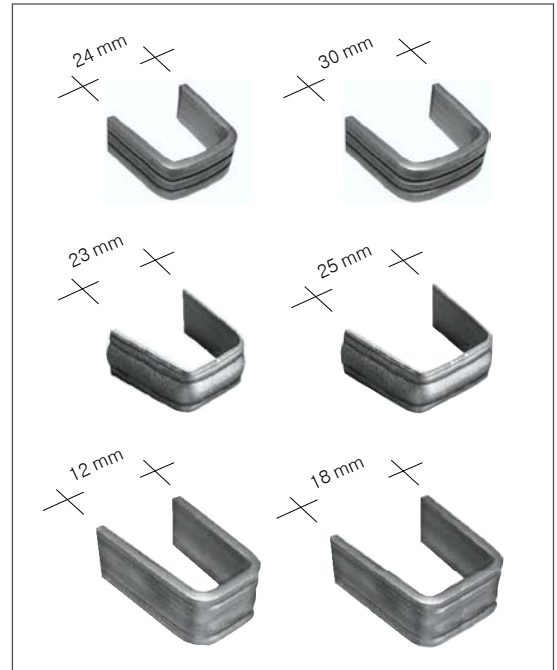

STRIP FOR COLLARS - Serie CA



**GRHM**

Groove & Hammered

16 X 16

16 X 16

12 X 12

16 X 8

12 X 6



copyright reproduction prohibited



SERIE "HD"

Handrails & Starters

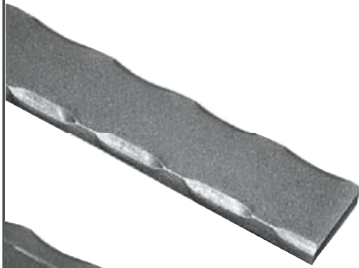

**HD-109** (40x8) 3mt./10ft.  
(7.530 kg.-16.596 lbs.)  
**HD-110** (40x12) 3mt./10ft.  
(11.300 kg.-24.905 lbs.)  
**HD-111** (40x6) 3mt./10ft.  
(5.652 kg.-12.457 lbs.)



**HD-209** (40x8) 3mt./10ft.  
(7.530 kg.-16.596 lbs.)  
**HD-210** (40x12) 3mt./10ft.  
(11.300 kg.-24.905 lbs.)  
**HD-211** (40x6) 3mt./10ft.  
(5.652 kg.-12.457 lbs.)



**HD-309** (40x8) 3mt./10ft.  
(7.530 kg.-16.596 lbs.)  
**HD-310** (40x12) 3mt./10ft.  
(11.300 kg.-24.905 lbs.)  
**HD-311** (40x6) 3mt./10ft.  
(5.652 kg.-12.457 lbs.)



**HD-409** (40x8) 3mt./10ft.  
(7.530 kg.-16.596 lbs.)  
**HD-410** (40x12) 3mt./10ft.  
(11.300 kg.-24.905 lbs.)  
**HD-411** (40x6) 3mt./10ft.  
(5.652 kg.-12.457 lbs.)



**HD-509** (40x8) 3mt./10ft.  
(7.530 kg.-16.596 lbs.)  
**HD-510** (40x12) 3mt./10ft.  
(11.300 kg.-24.905 lbs.)  
**HD-511** (40x6) 3mt./10ft.  
(5.652 kg.-12.457 lbs.)

Embossing roll for HD-409



**HD-609** 40x8  
(1.256 kg.-2.678 lbs.)  
**HD-610** 40x12  
(1.884 kg.-4.152 lbs.)  
**HD-611** 40x6  
(0.942 kg.-2.076 lbs.)  
**HD-614** 40x11  
(1.400 kg.-3.086 lbs.)  
**HD-613** 50x10  
(1.650 kg.-3.637 lbs.)

**HD-809** 40x8  
(1.507 kg.-3.321 lbs.)  
**HD-811** 40x6  
(1.130 kg.-2.491 lbs.)  
**HD-813** 50x10  
(1.980 kg.-4.364 lbs.)  
**HD-814** 40x11  
(1.680 kg.-3.703 lbs.)

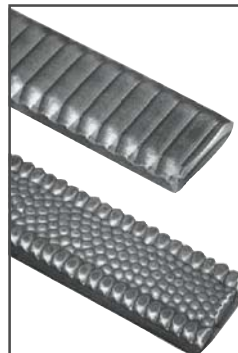

**HD-1010** (40x12) 3mt./10ft.  
(11.300 kg.-24.905 lbs.)

**HD-1109** (40x8) 3mt./10ft.  
(7.536 kg.-16.596 lbs.)  
**HD-1110** (40x12) 3mt./10ft.  
(11.300 kg.-24.905 lbs.)  
!!! Best with 40 x 12 !!!

Shaped Handrail

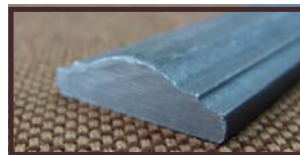

**HD-414** (40x11) 3mt./10ft.  
(8.400 kg.-18.514 lbs.)  
**HD-415** (50x14) 3mt./10ft.  
(13.200 kg.-29.093 lbs.)

Half moon Handrail

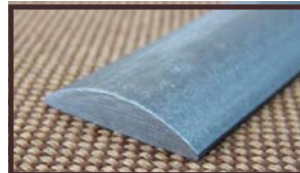

**HD-412** (40x12) 3mt./10ft.  
(9.000 kg.-19.836 lbs.)  
**HD-413** (50x10) 3mt./10ft.  
(9.900 kg.-21.820 lbs.)



**HD-709** 40x8  
(1.882 kg.-4.148 lbs.)  
**HD-710** 40x12  
(3.950 kg.-8.706 lbs.)  
**HD-711** 40x6  
(1.413 kg.-3.114 lbs.)  
**HD-612** 40x12  
(3.000 kg.-6.612 lbs.)  
**HD-613** 50x10  
(2.475 kg.-5.455 lbs.)  
**HD-614** 40x11  
(2.100 kg.-4.628 lbs.)  
**HD-615** 50x14  
(4.400 kg.-9.698 lbs.)

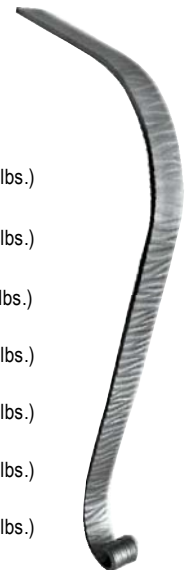

**HD-914** 40x11  
(0.980 kg.-2.160 lbs.)  
All section in 40x12  
upon request with  
this shape

WHEN ORDER FINALS MARK FINISH (E.G. HD-609/409)