

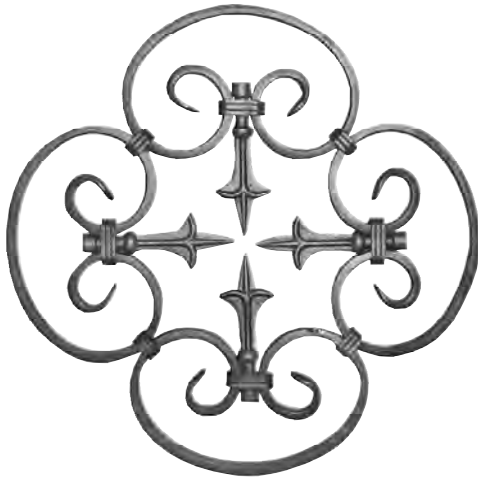

SERIE "R"
Venetian Rosettes

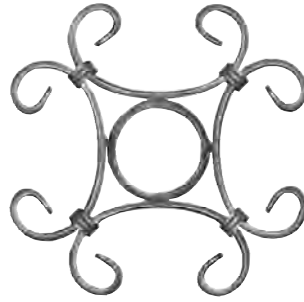

R-801/C (12 x 6)
2.340 kg.-5.157 lbs.
R-814/C (16 x 8)
3.540 kg.-7.802 lbs.
Dim.380 x 380
15" x 15"



R-1001/C (12 x 6)
0.840 kg.-1.851 lbs.
Dim.220 x 220
8"11/16 x 8"11/16



R-1101/C (12 x 6)
1.015 kg.-2.237 lbs.
Dim.220 x 220
8"11/16 x 8"11/16

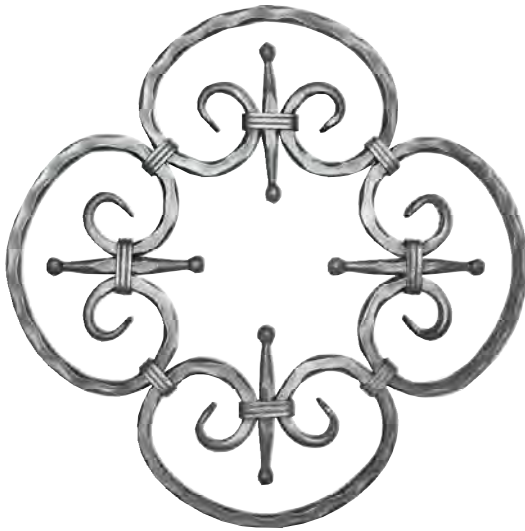

R-505/C HM (12 x 12)
3.780 kg.-8.331 lbs.
Dim.420 x 420
16"1/2 x 16"1/2

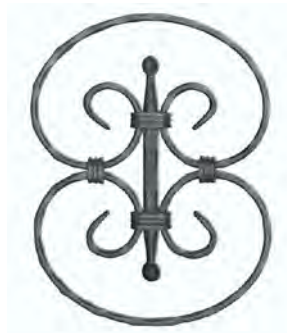

R-901 HM (12 x 6)
0.983 kg.-2.167 lbs.
R-901/C HM (12 x 6)
1.005 kg.-2.215 lbs.
Dim.210 x 220
8"1/4 x 8"11/16

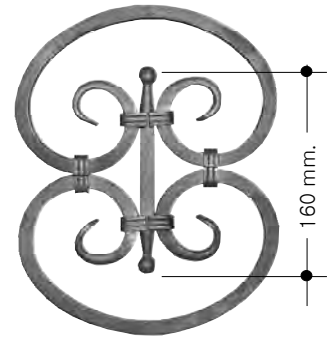

R-905 HM (12 x 12)
1.780 kg.-3.923 lbs.
R-905/C HM (12 x 12)
1.952 kg.-4.302 lbs.
Dim.210 x 270
8"1/4 x 10"5/8

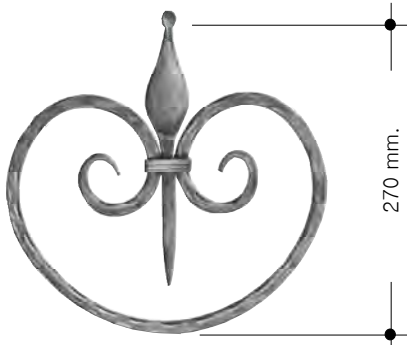

R-1205/A HM (12 x 12)
1.470 kg.-3.240 lbs.
Dim.290 x 300
11"7/16 x 11"3/4

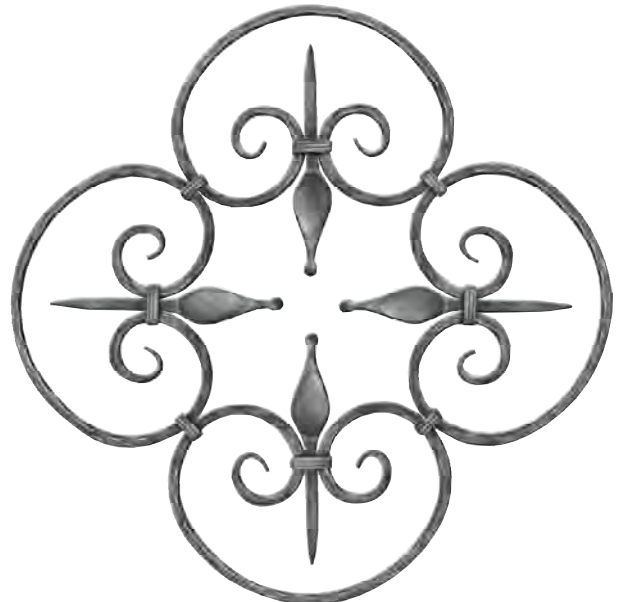

R-1205/C HM (12 x 12)
5.850 kg.-12.893 lbs.
Dim.640 x 640
25"1/4 x 25"1/4

copyright reproduction prohibited



SERIE "P"
Assembled Pickets



P-101



P-201 HM

P-101
1.830 kg.-4.033 lbs.
Picket made of flat 12 X 6
w/out collars
Dim.250 x 725
9"13/16 x 28"1/2

P-102-F
2.280 kg.-5.025 lbs.
Picket made of flat 14 X 6
w/out collars forged finals
Dim.250 x 725
9"13/16 x 28"1/2

P-201
1.880 kg.-4.144 lbs.
Picket made of flat 12 X 6
w/out collars
Dim.250 x 725
9"13/16 x 28"1/2

P-202-F
2.345 kg.-5.168 lbs.
Picket made of flat 14 X 6
w/out collars forged finals
Dim.250 x 725
9"13/16 x 28"1/2

P-301
1.320 kg.-2.909 lbs.
Picket made of flat 12 X 6
w/out collars
Dim.250 x 725
9"13/16 x 28"1/4

P-302-F
1.647 kg.-3.630 lbs.
Picket made of flat 14 X 6
w/out collars forged finals
Dim.250 x 725
9"13/16 x 28"-4/8

P-405 HM
1.830 kg.-4.033 lbs.
Picket made of square
12 X 12 & G-001 HM
in flat 12 X 6
Dim.140 x 900
5"1/2 x 35"7/16

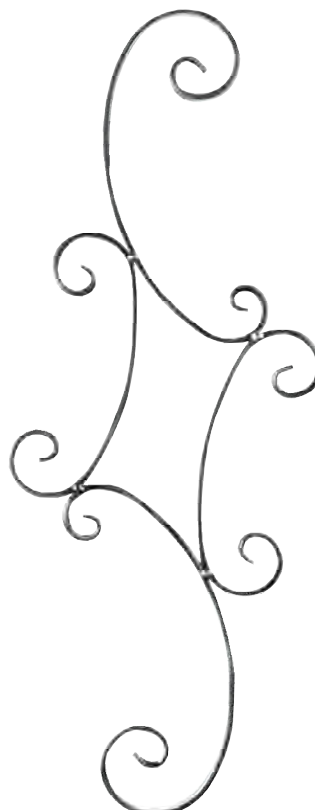

P-301

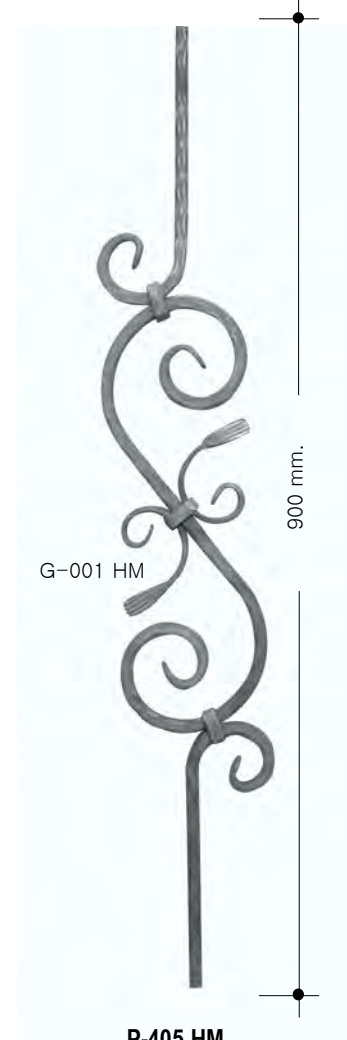

P-405 HM



copy right reserved prohibited



Assembled Pickets

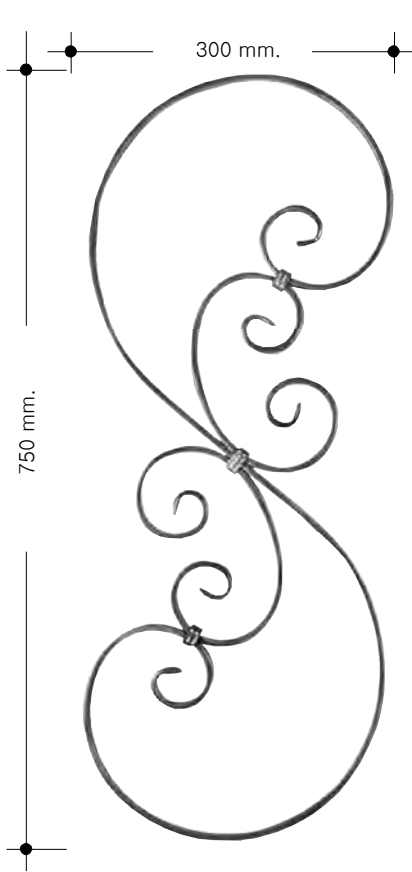

P-503

P-503
4.030 kg.-8.882 lbs.
Panel made of flat 20 X 8
with collars 20 X 4
Dim.300 x 750 mm.
11³/₄ x 29¹/₂



P-505 HM

P-505 HM
3.950 kg.-8.706 lbs.
Panel made of square 12 X 12
with collars 12 X 3
Dim.300 x 750 mm.
11³/₄ x 29¹/₂



P-605/A HM

3.450 kg.-7.603 lbs.
Panel made of Sq.12 X 12 taper
with SL3 & collars 12 X 3
Dim.300 x 750 mm.
11³/₄ x 29¹/₂



750 mm.

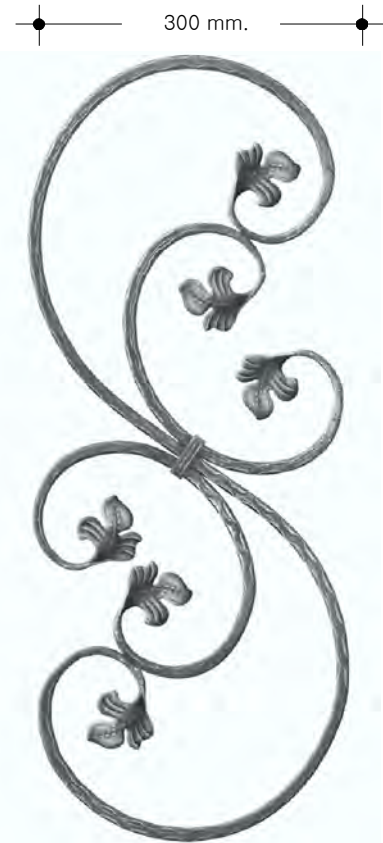

P-605/B HM

3.500 kg.-7.714 lbs.
Panel made of Sq.12 X 12 taper
with SL5 & collars 12 X 3
Dim.300 x 750 mm.
11³/₄ x 29¹/₂



SERIE "P"

Assembled Pickets

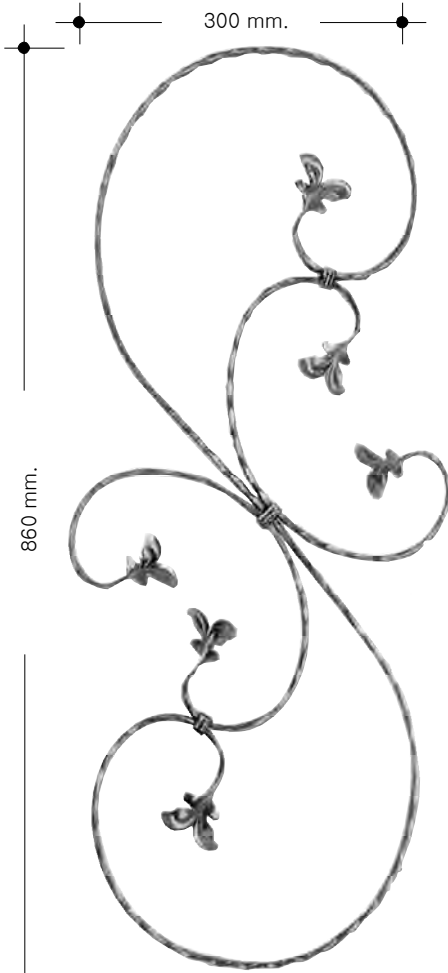

P-601/A HM

P-601/A
 2.225 kg.-4.904 lbs.
 Panel made of flat 12 X 6
 with SL3 & collars 12 X 3
 Dim.300 x 860 mm.
 11"6/8 x 35"7/16

P-601/As
 1.950 kg.-4.298 lbs.
 Panel made of flat 12 X 6
 with SL3 & collars 12 X 3
 Dim.290 x 750 mm.
 11"1/2 x 29"1/2

P-601/B
 2.225 kg.-4.904 lbs.
 Panel made of flat 12 X 6
 with SL5 & collars 12 X 3
 Dim.300 x 860 mm.
 11"6/8 x 35"7/16

P-601/Bs
 1.950 kg.-4.298 lbs.
 Panel made of flat 12 X 6
 with SL5 & collars 12 X 3
 Dim.290 x 750 mm.
 11"1/2 x 29"1/2

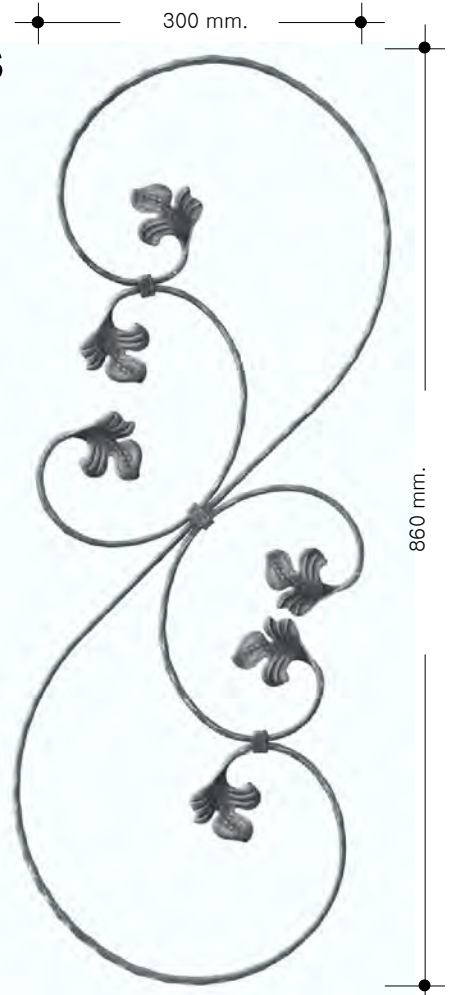

P-601/B HM

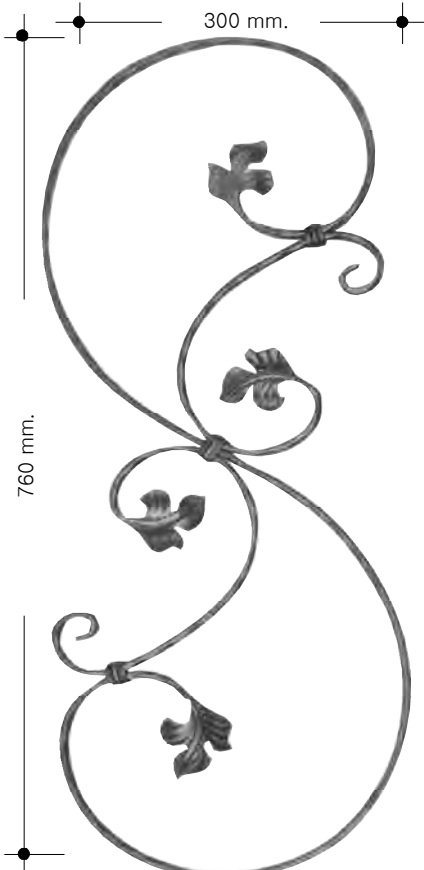

P-1401/A HM

P-1401/A
 1.820 kg.-4.011 lbs.
 Panel made of flat 12 X 6
 with 4 SL5 & collars 12 X 3
 Dim.300 x 760 mm.
 11"6/8 x 29"15/16

P-1401/B
 1.820 kg.-4.011 lbs.
 Panel made of flat 12 X 6
 with 2 SL7 & 2 SL5
 with collars 12 X 3
 Dim.300 x 760 mm.
 11"6/8 x 29"15/16

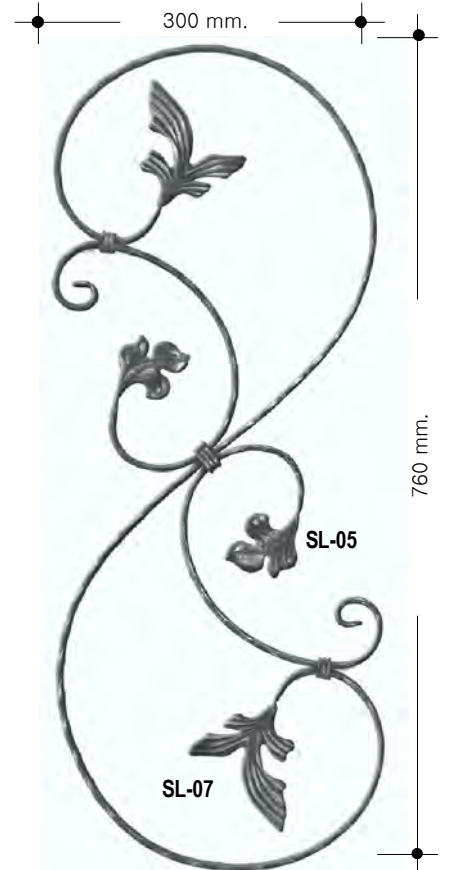

P-1401/B HM



Assembled Pickets

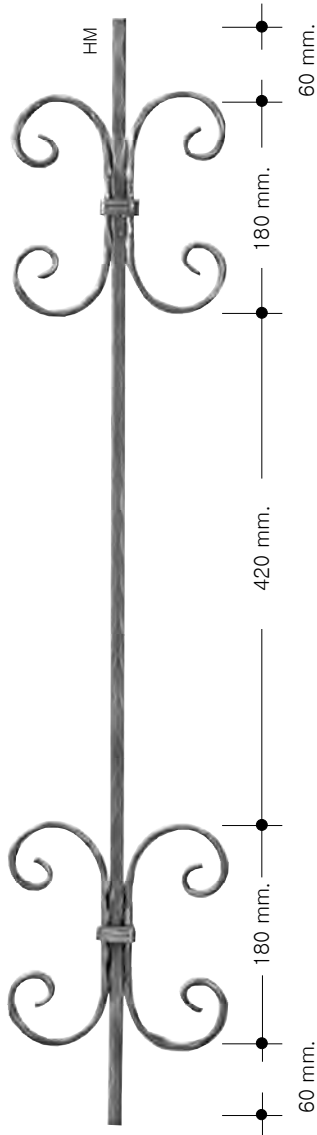

P-701 HM
2.100 kg.-4.628 lbs.
Dim.175 x 900 mm.
6"7/8 x 35"7/16

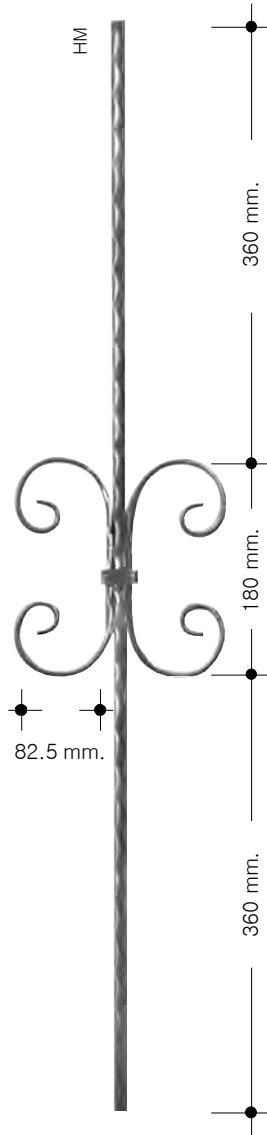

P-801 HM
1.590 kg.-3.504 lbs.
Dim.175 x 900 mm.
6"7/8 x 35"7/16

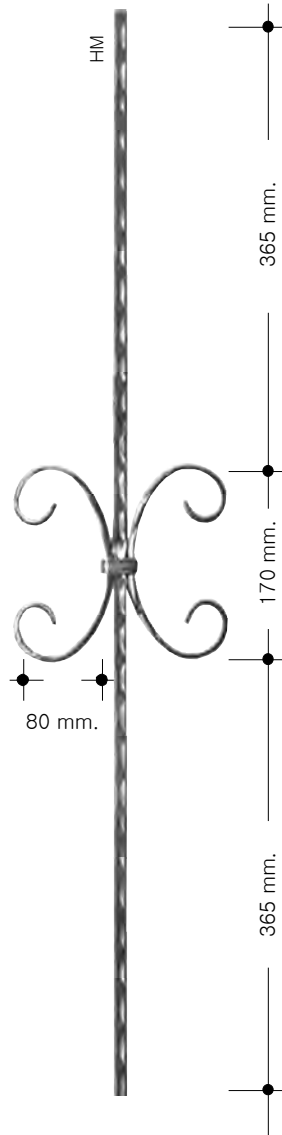

P-901 HM
1.437 kg.-3.167 lbs.
Dim.170 x 900 mm.
6"11/16 x 35"7/16

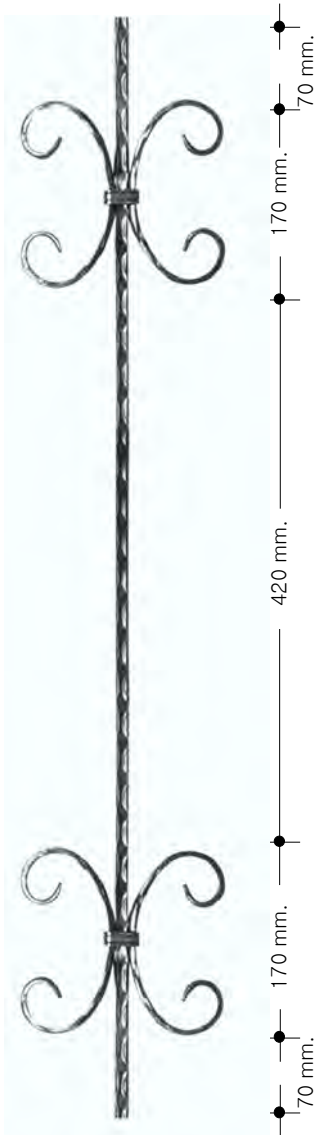

P-1001
1.848 kg.-4.073 lbs.
Dim.170 x 900 mm.
6"11/16 x 35"7/16

copyright reproduction prohibited





SERIE "P"

Assembled Pickets

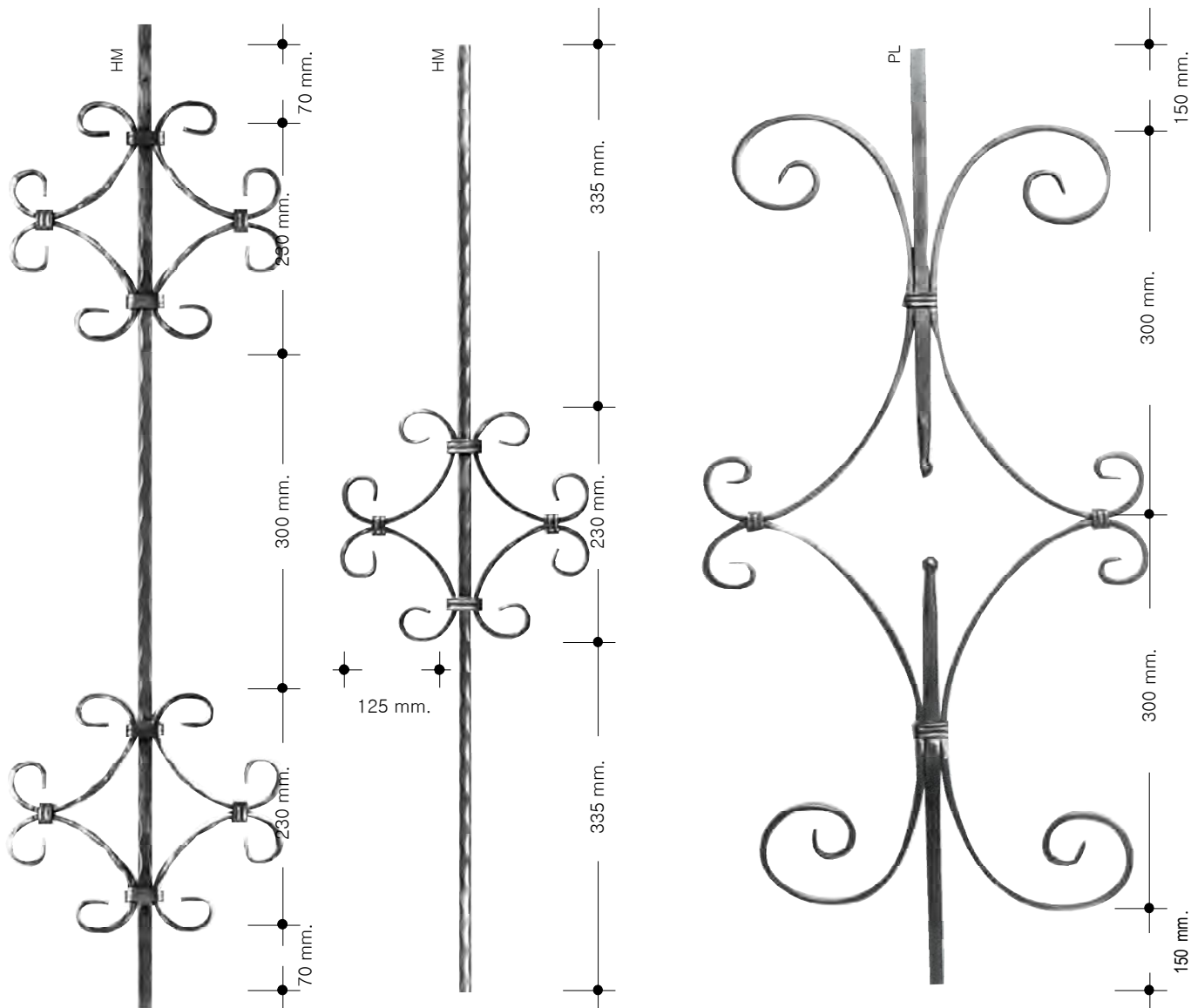

P-1101HM
 2.500 kg.-5.510 lbs.
 Dim.260 x 900 mm.
 10"2/8 x 35"7/16

P-1201HM
 1.790 kg.-3.945 lbs.
 Dim.260 x 900 mm.
 10"2/8 x 35"7/16

P-1301
 2.700 kg.-5.951 lbs.
 Dim.355 x 900 mm.
 14" x 35"7/16

copyright reproduction prohibited





Assembled Pickets

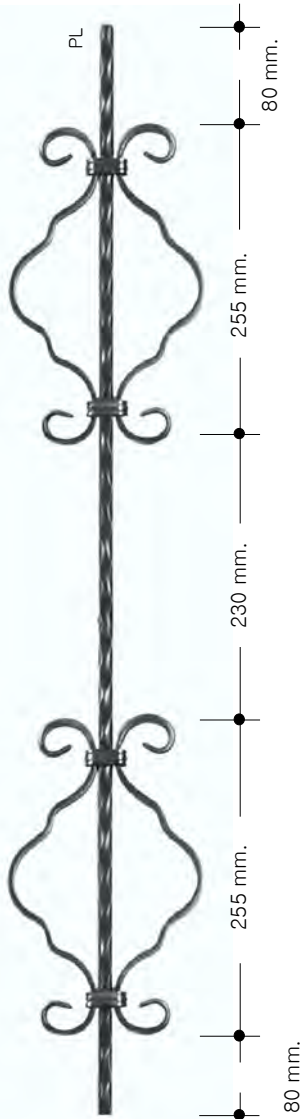

P-1501 HM

2.060 kg.-4.540 lbs.
Dim.160 x 900 mm.
2"5/16 x 35"7/16

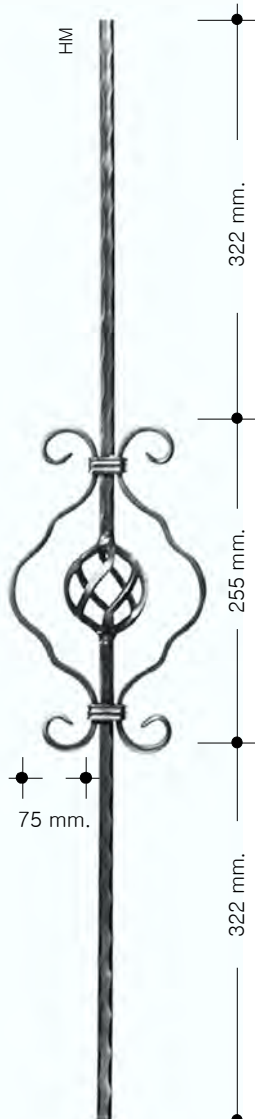

P-1601 HM

2.140 kg.-4.717 lbs.
Dim.160 x 900 mm.
2"5/16 x 35"7/16

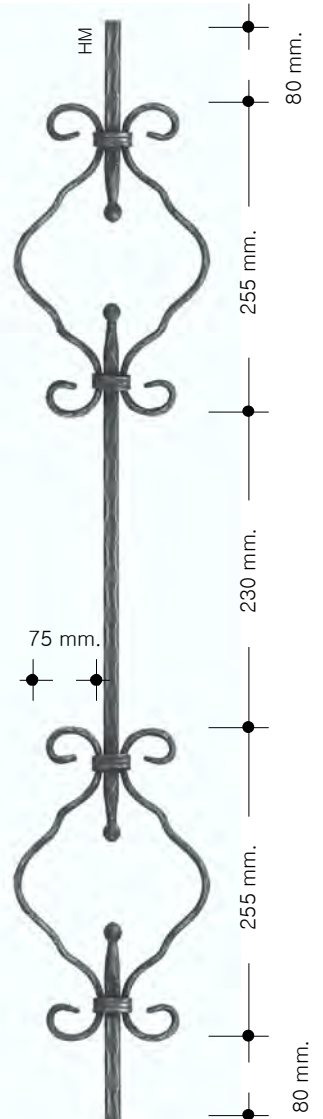

P-7401HM

1.900 kg.-4.188 lbs.
Dim.160 x 900 mm.
2"5/16 x 35"7/16





SERIE "P"

Assembled Pickets

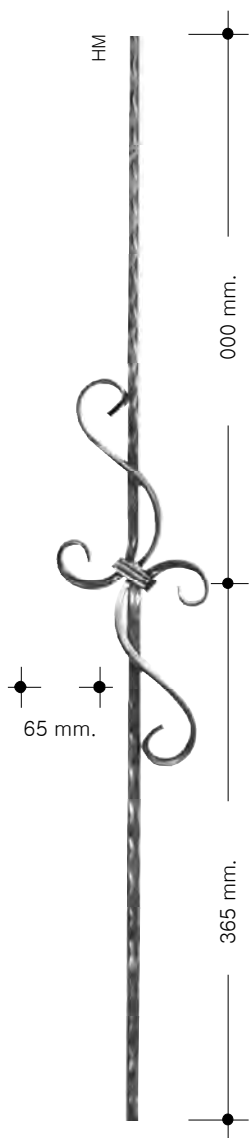

P-1701HM
 1.550 kg.-3.416 lbs.
 Dim.140 x 900 mm.
 5⁴/₈ x 35⁷/₁₆

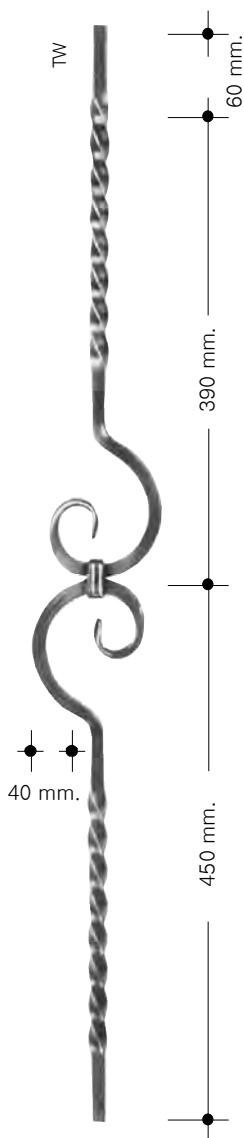

P-1805 TW
 1.375 kg.-3.031 lbs.
 Dim.90 x 900 mm.
 3⁹/₁₆ x 35⁷/₁₆

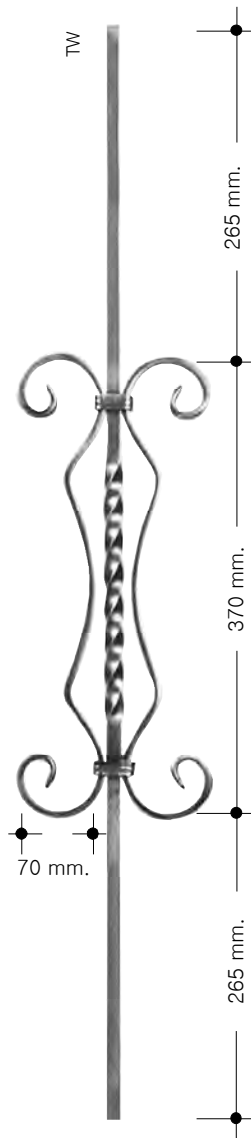

P-1901TW
 1.760 kg.-3.879 lbs.
 Dim.150 x 900 mm.
 5⁷/₈ x 35⁷/₁₆

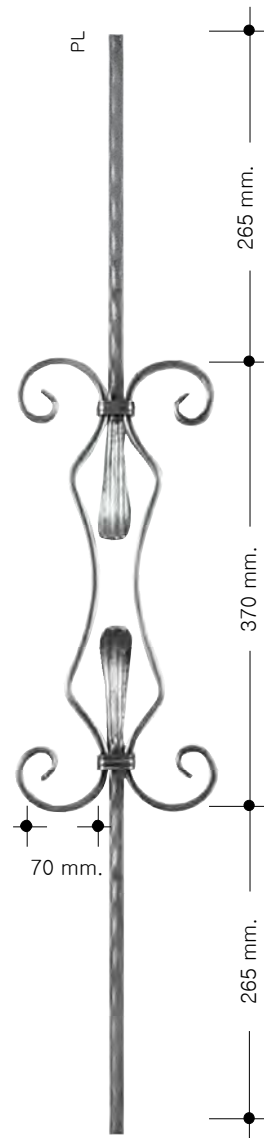

P-2001 HM
 1.670 kg.-3.681 lbs.
 Dim.150 x 900 mm.
 5⁷/₈ x 35⁷/₁₆

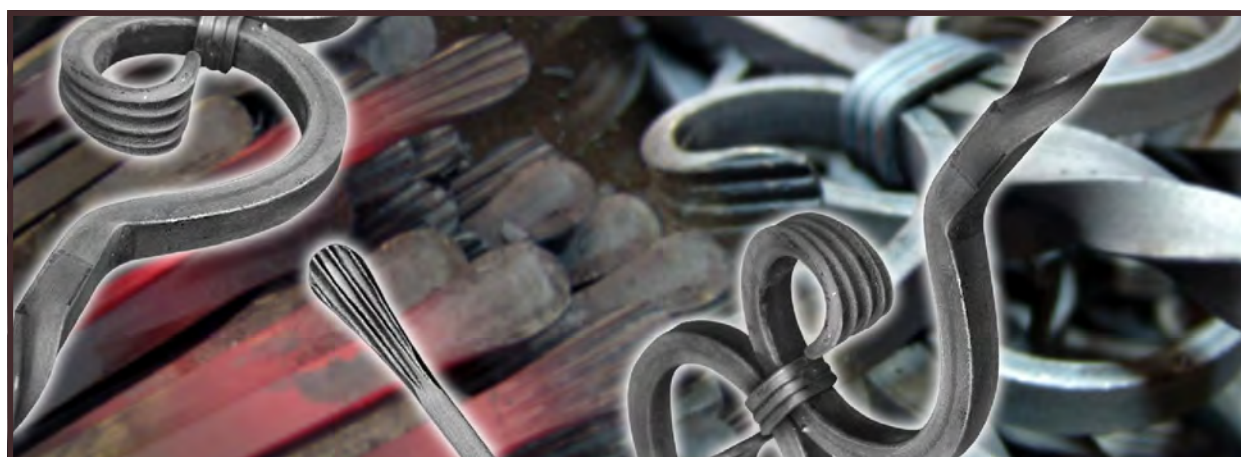

copyright reproduction prohibited



Assembled Pickets

copyright reproduction prohibited

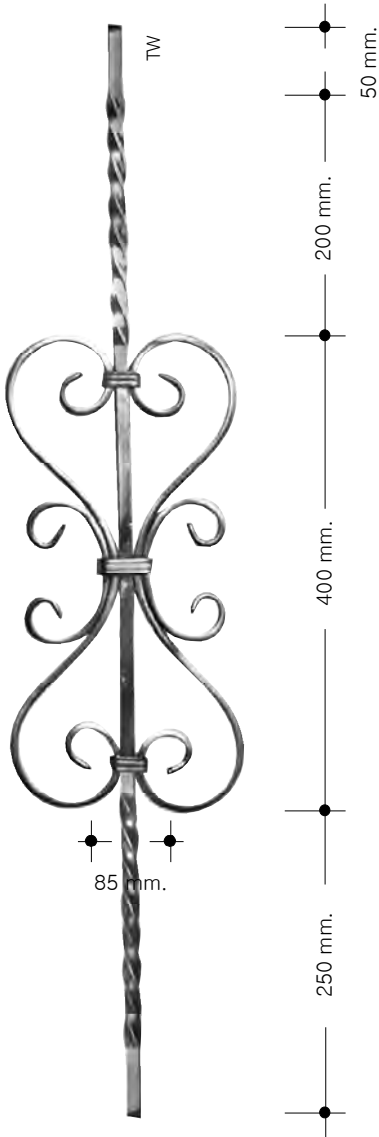

P-2101TW

2.300 kg.-5.069 lbs.
Dim.260 x 900 mm.
10"2/8 x 35"7/16

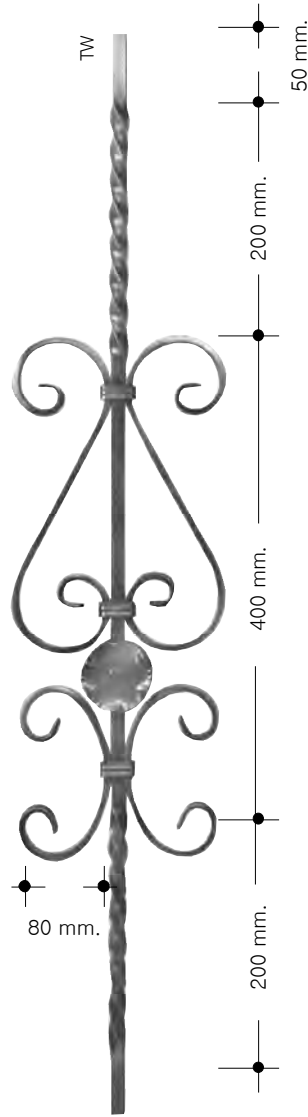

P-2201TW

2.210 kg.-4.871 lbs.
Dim.190 x 900 mm.
7"4/8 x 35"7/16

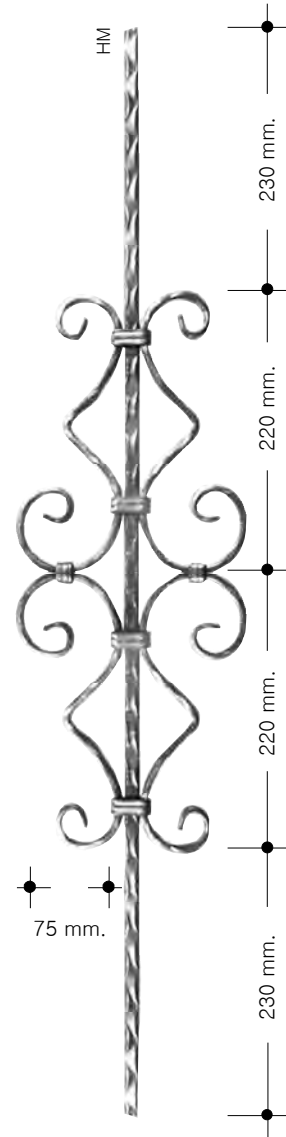

P-2301HM

2.220 kg.-4.893 lbs.
Dim.140 x 900 mm.
5"4/8 x 35"7/16





Assembled Pickets

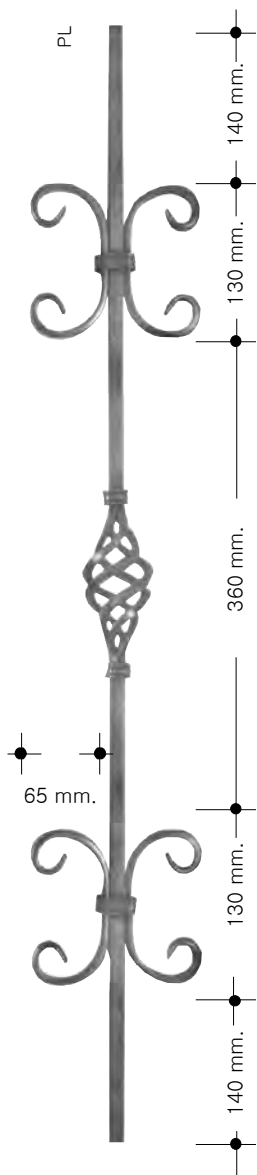

P-2401
 1.900 kg.-4.188 lbs.
 Dim.150 x 900 mm.
 5"7/8 x 35"7/16

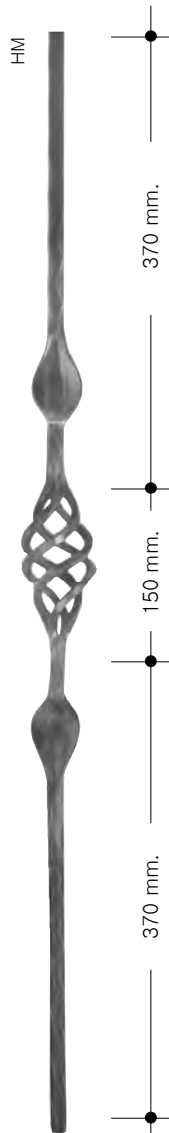

P-2505 HM
 1.088 kg.-2.398 lbs.
 Dim.55 x 900 mm.
 12"1/8 x 5"2/8

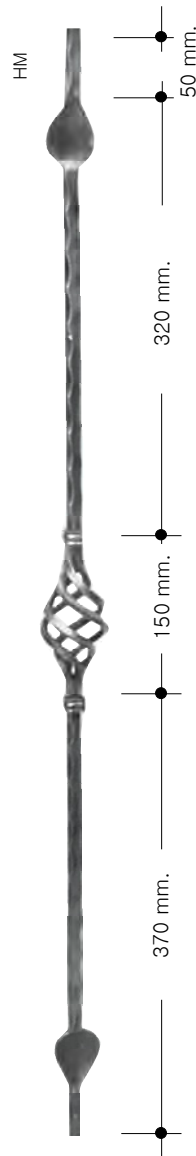

P-2505/A HM
 1.125 kg.-2.480 lbs.
 Dim.55 x 900 mm.
 12"1/8 x 5"2/8





Assembled Pickets

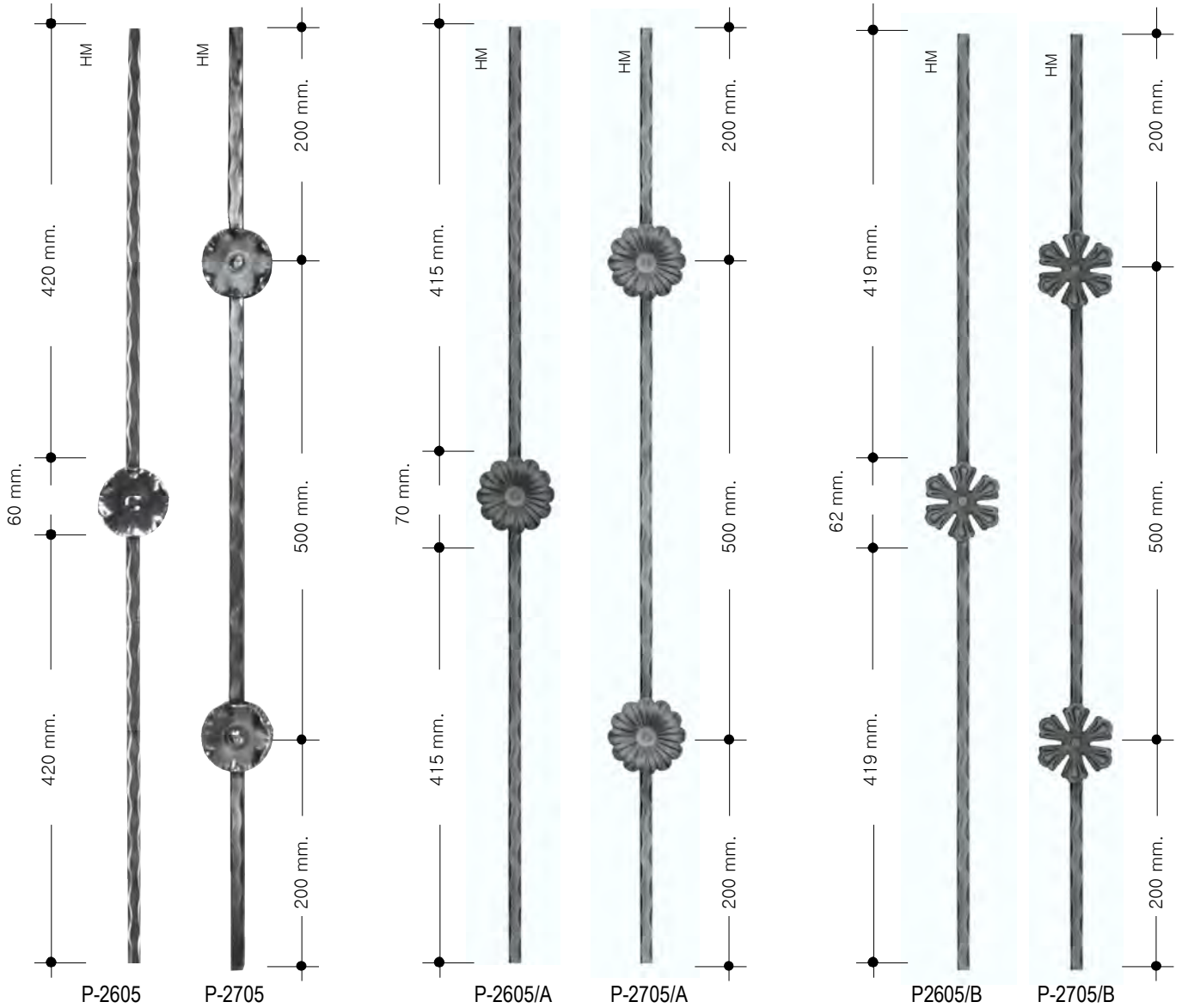

P-2605 HM
 1.065 kg.-2.347 lbs.
 Dim.60 x 800 mm.
 2"3/8 x 31"4/8

P-2705 HM
 1.200 kg.-2.645 lbs.
 Dim.60 x 800 mm.
 2"3/8 x 31"4/8

P-2605/A HM
 1.120 kg.-2.468 lbs.
 Dim.70 x 800 mm.
 2"3/8 x 31"4/8

P-2705/A HM
 1.220 kg.-2.689 lbs.
 Dim.70 x 800 mm.
 2"3/8 x 31"4/8

P-2605/B HM
 1.150 kg.-2.468 lbs.
 Dim.62 x 800 mm.
 2"3/8 x 31"4/8

P-2705/B HM
 1.280 kg.-2.821 lbs.
 Dim.62 x 800 mm.
 2"3/8 x 31"4/8



copyright reproduction prohibited

Assembled Pickets

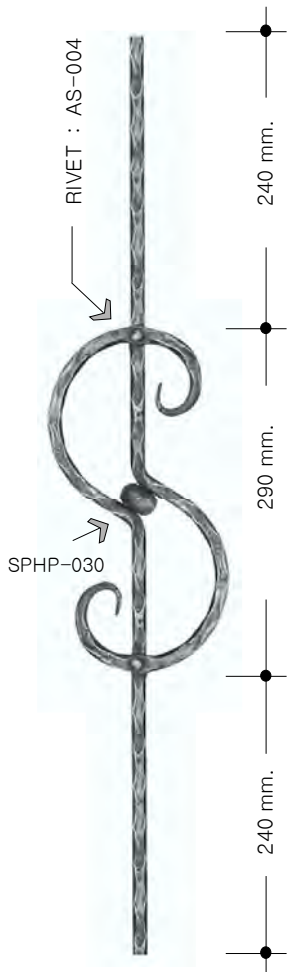

P-2805/B HM

1.720 kg.-3.791 lbs.
Dim.125 x 760 mm.
4"15/16 x 29"15/16

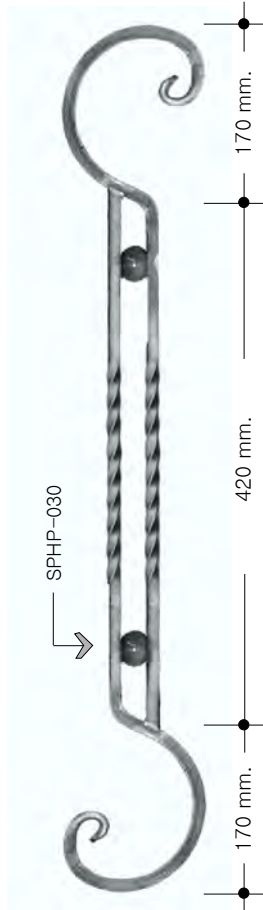

P-2805/C TW

2.025 kg.-4.463 lbs.
Dim.160 x 770 mm.
2"5/16 x 30"5/16

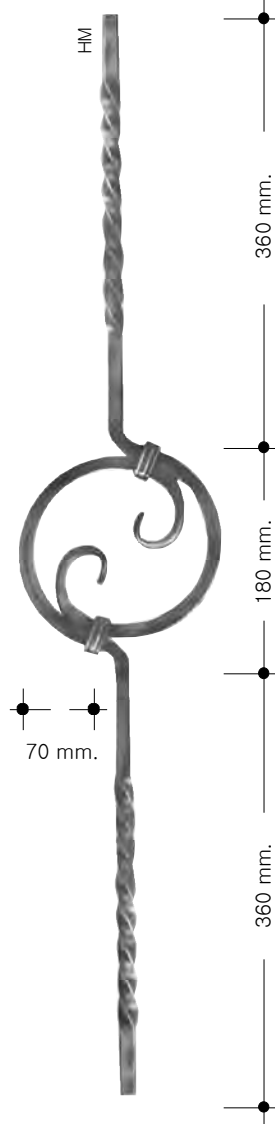

P-2805 HM

1.670 kg.-3.681 lbs.
Dim.155 x 900 mm.
6"1/8 x 35"7/16

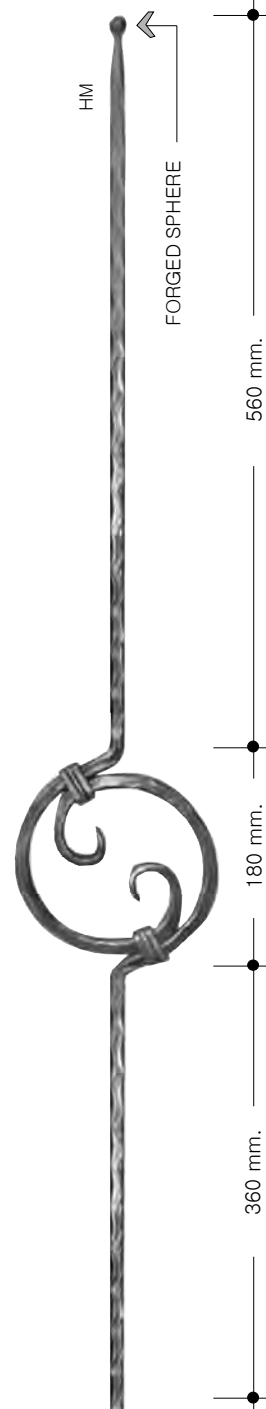

P-2805/A HM

1.895 kg.-40177 lbs.
Dim.155 x 1100 mm.
6"1/8 x 43"5/16





Assembled Pickets

copyright reproduction prohibited

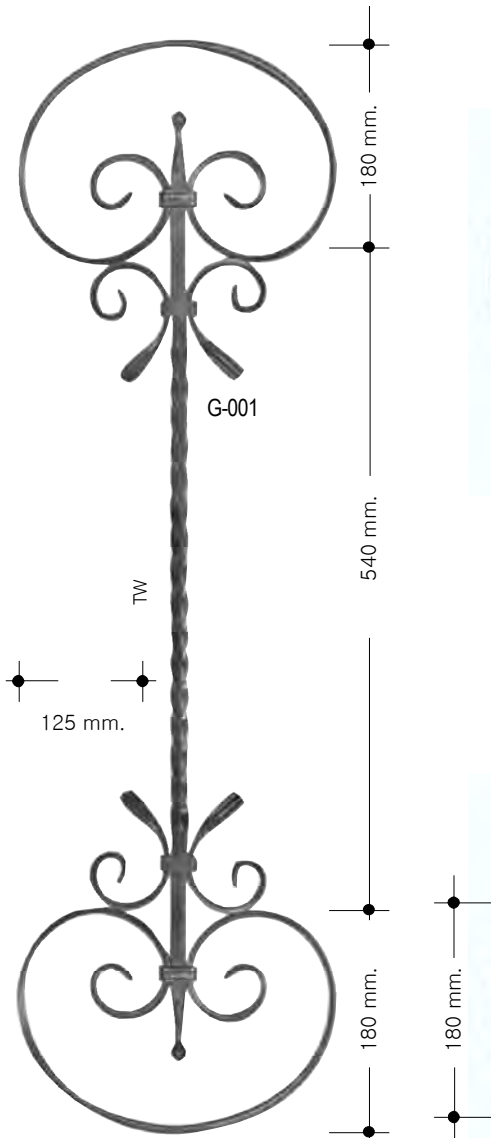

P-2901TW
2.530 kg.-5.576 lbs.
Dim.260 x 900 mm.
10"2/8 x 35"7/16

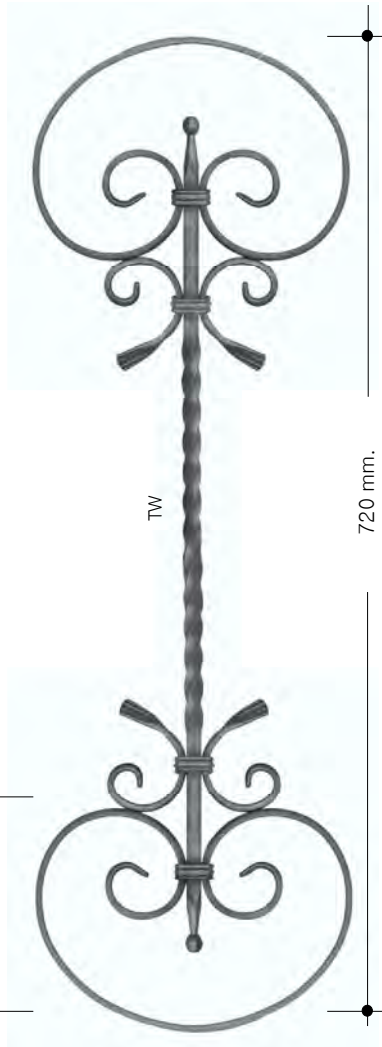

P-2901/A TW
2.530 kg.-5.576 lbs.
Dim.260 x 720 mm.
10"2/8 x 35"7/16

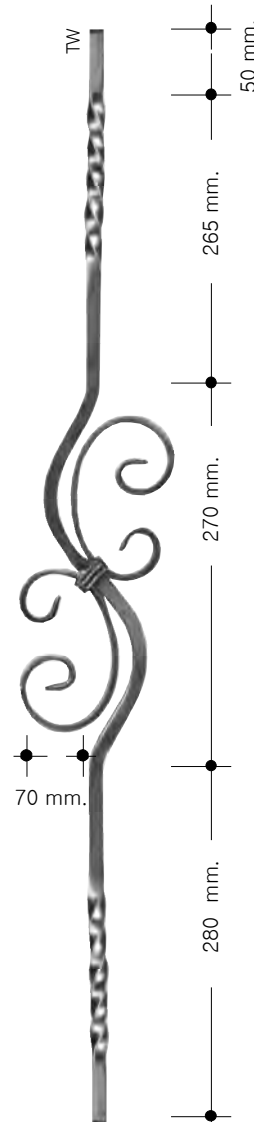

P-3001TW
1.530 kg.-3.372 lbs.
Dim.130 x 900 mm.
5"1/8 x 35"7/16

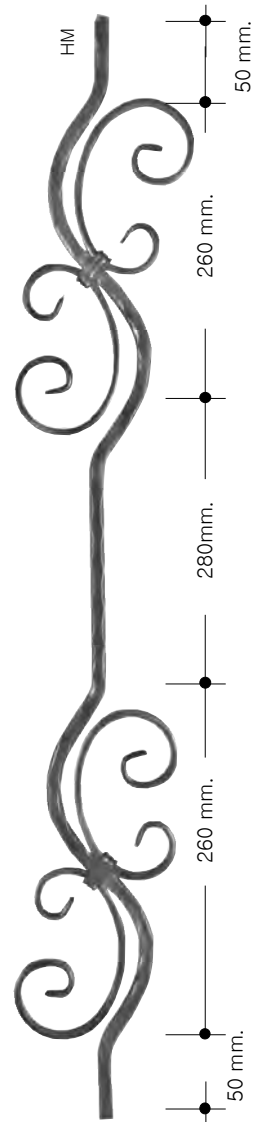

P-3101 HM
2.020 kg.-4.452 lbs.
Dim.130 x 900 mm.
5"1/8 x 35"7/16





SERIE "P"

Assembled Pickets

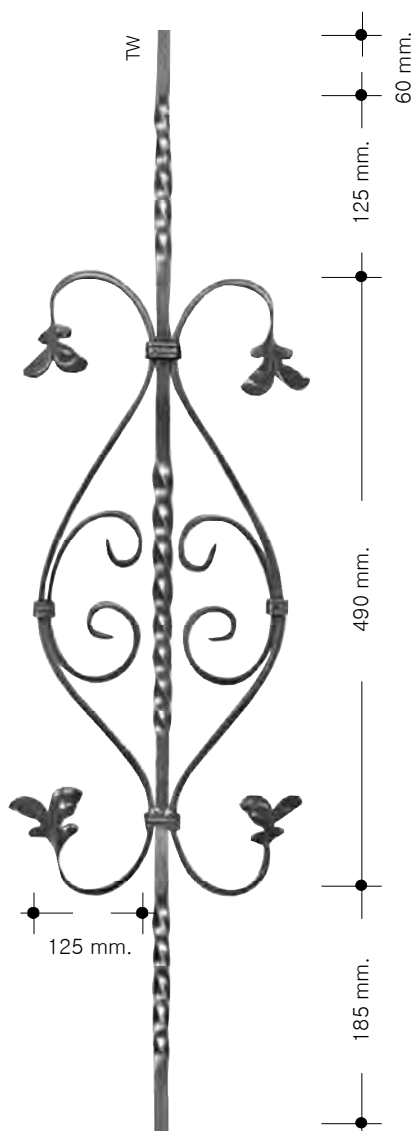

P-3201 TW
 2.540 kg.-5.598 lbs.
 Dim.220 x 900 mm.
 8"11/16 x 35"7/16

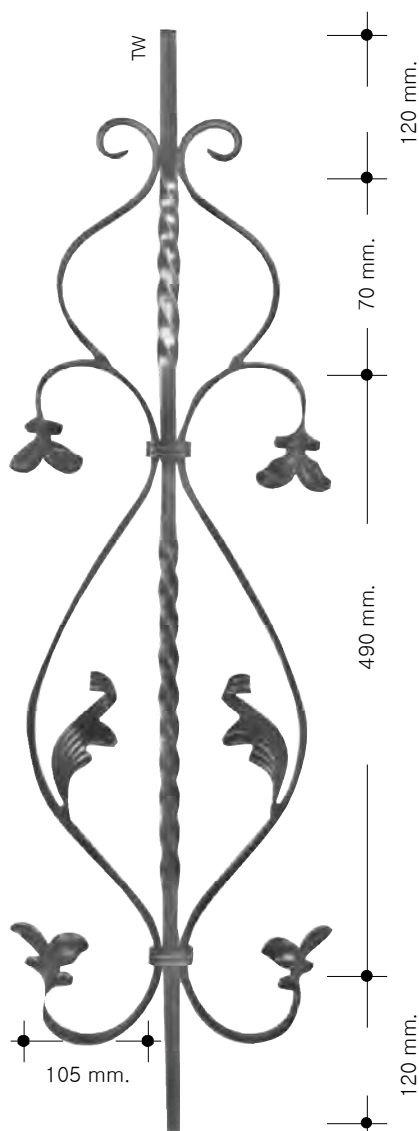

P-3501 TW
 2.720 kg.-5.995 lbs.
 Dim.220 x 900 mm.
 8"11/16 x 35"7/16

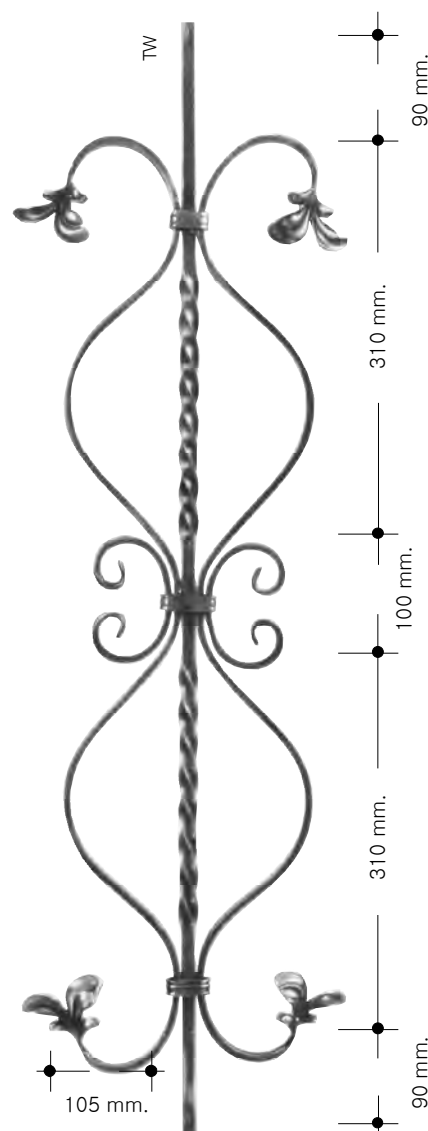

P-3601 TW
 2.660 kg.-5.863 lbs.
 Dim.195 x 900 mm.
 7"11/16 x 35"7/16

copyright reproduction prohibited

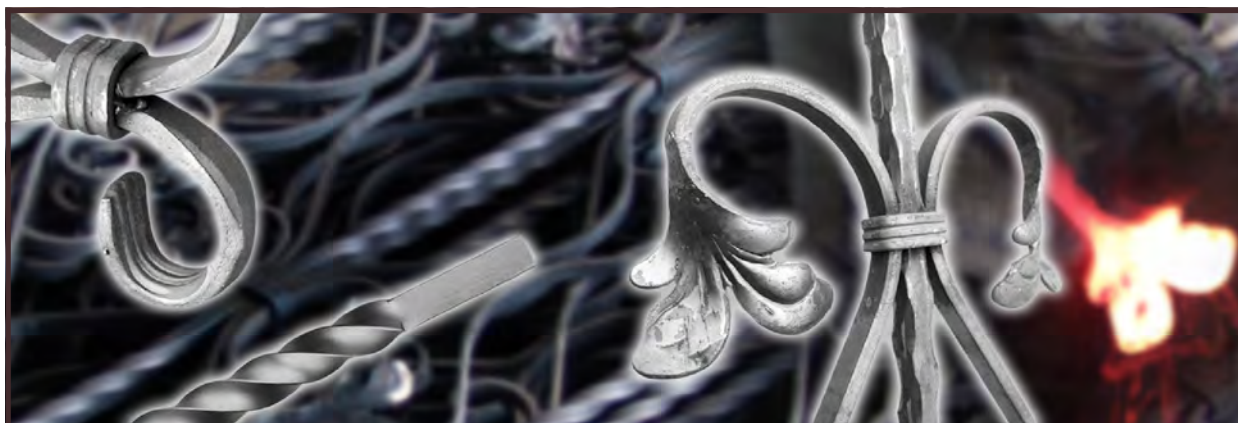



SERIE "P"

Assembled Pickets

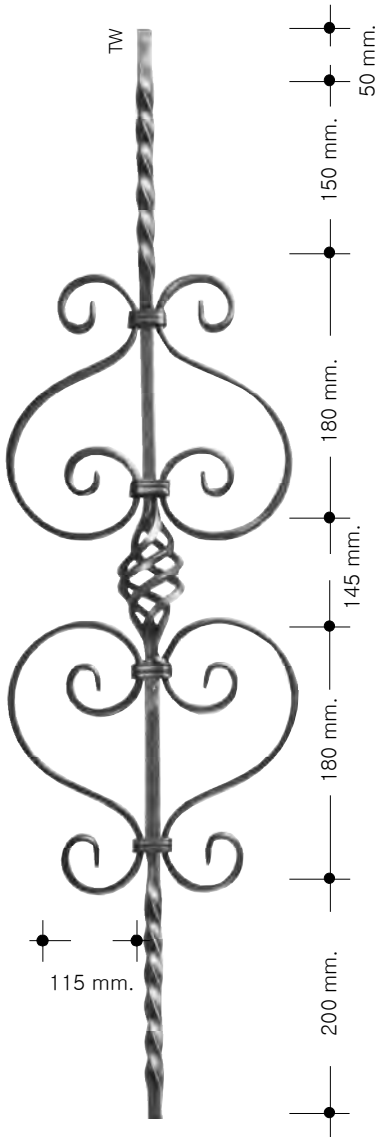

P-3301 TW
 2.500 kg.-5.510 lbs.
 Dim.240 x 900 mm.
 9"7/16 x 35"7/16

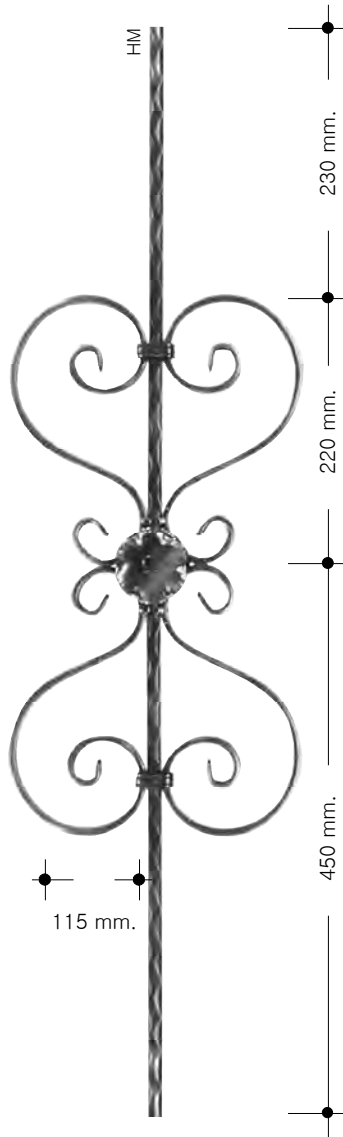

P-3401 HM
 2.430 kg.-5.356 lbs.
 Dim.240 x 900 mm.
 9"7/16 x 35"7/16

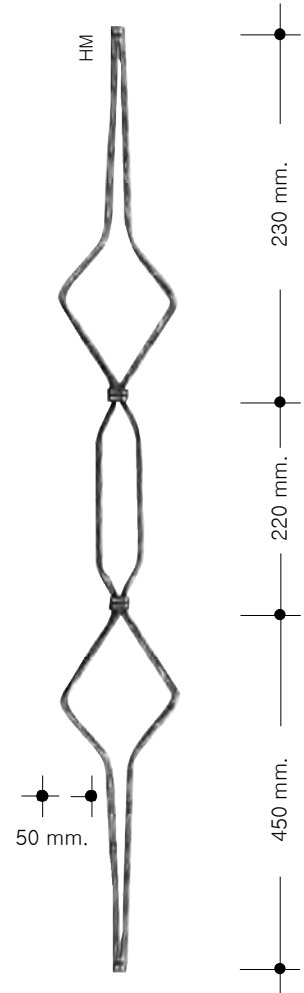

P-4601 HM
 0.980 kg.-2.160 lbs.
 Dim.110 x 750 mm.
 4"5/16 x 29"4/8





SERIE "P"

Assembled Pickets

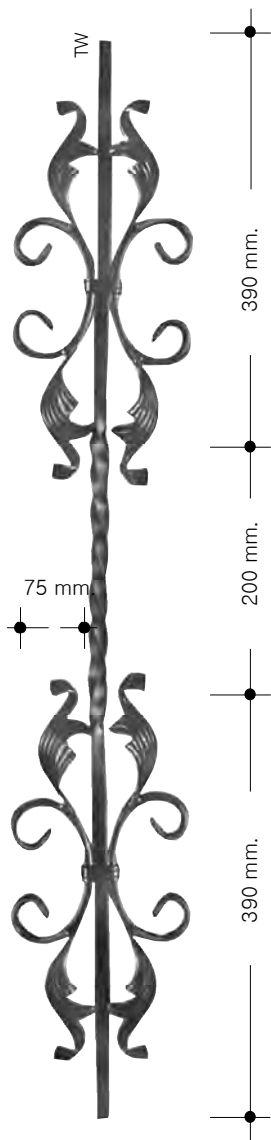

P-3701

2.150 kg.-4.739 lbs.
Dim.155 x 900 mm.
6"1/8 x 35"7/16

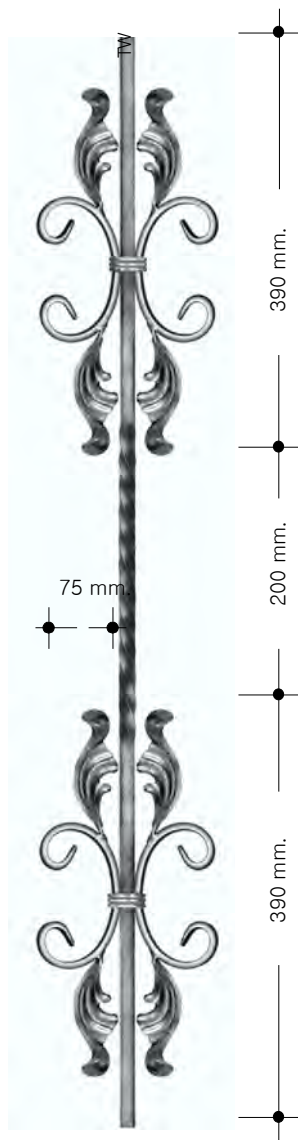

P-3701/A

2.150 kg.-4.739 lbs.
Dim.155 x 900 mm.
6"1/8 x 35"7/16

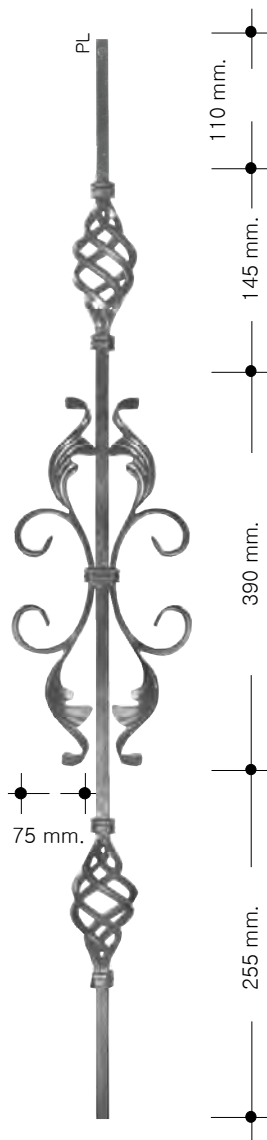

P-3801

1.820 kg.-4.001 lbs.
Dim.155 x 900 mm.
6"1/8 x 35"7/16

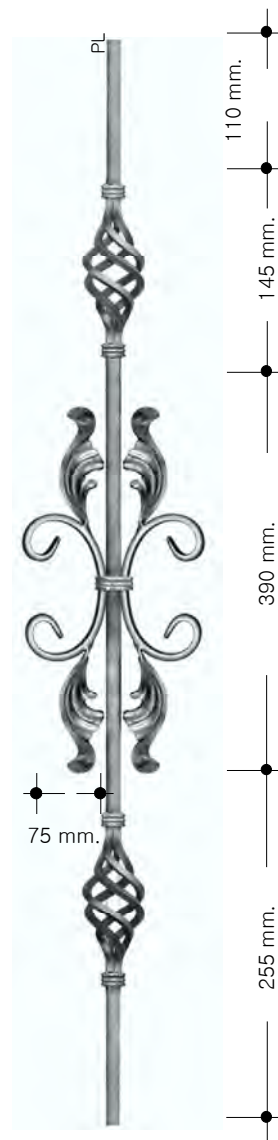

P-3801/A

1.820 kg.-4.001 lbs.
Dim.155 x 900 mm.
6"1/8 x 35"7/16





SERIE "P"

Assembled Pickets

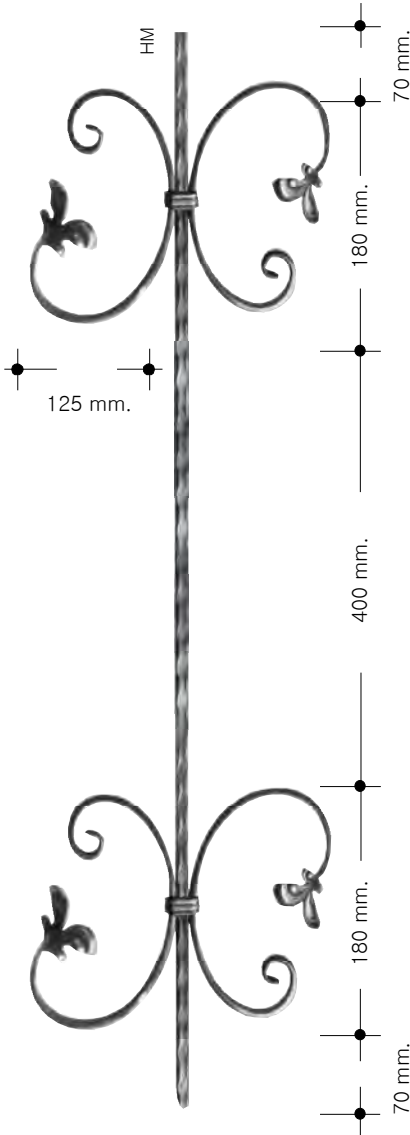

P-3901 HM

2.200 kg.-4.849 lbs.
Dim.240 x 900 mm.
9"7/16 x 35"7/16

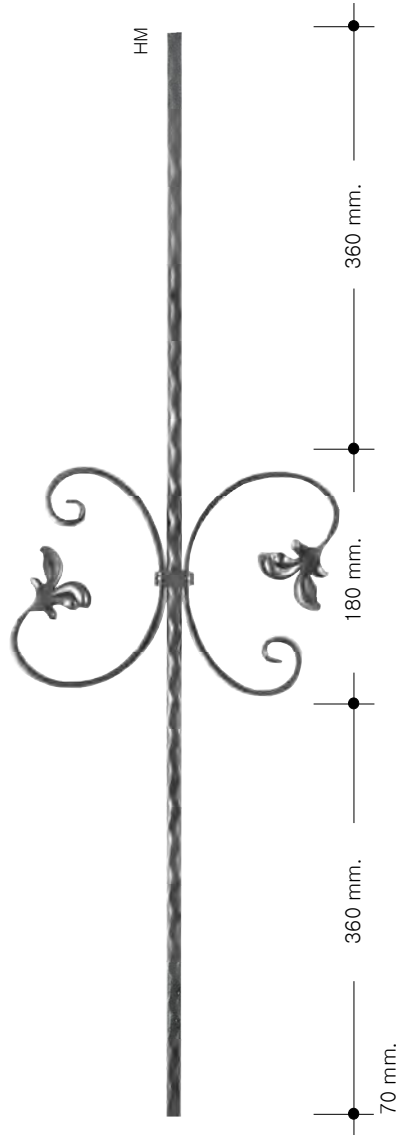

P-4001 HM

1.630 kg.-3.593 lbs.
Dim.240 x 900 mm.
9"7/16 x 35"7/16

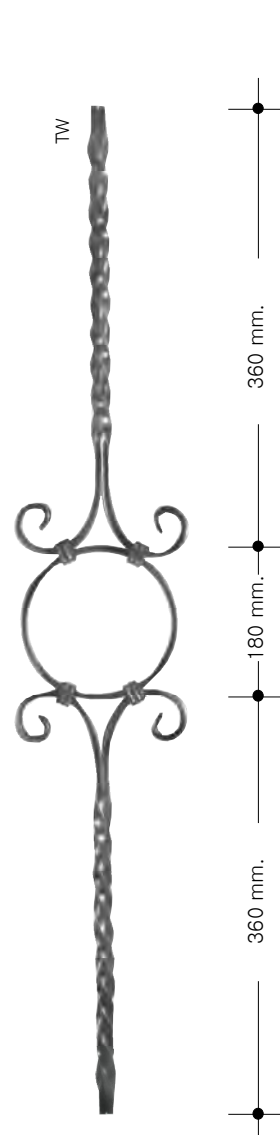

P-4401/D TW

1.420 kg.-3.130 lbs.
Dim.130 x 800 mm.
5"1/8 x 31"4/8



P-4701/D TW

1.640 kg.-3.615 lbs.
Dim.130 x 800 mm.
5"1/8 x 31"1/2





SERIE "P"

Assembled Pickets

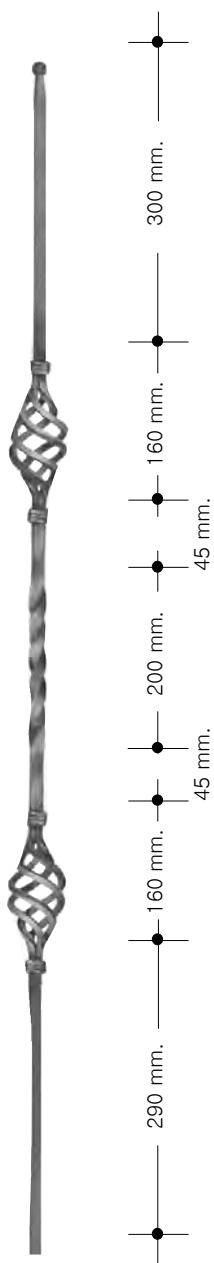

P-4105/A TW
 1.470 kg.-3.239 lbs.
 Dim.55 x 1200 mm.
 2"3/16 x 47"2/8

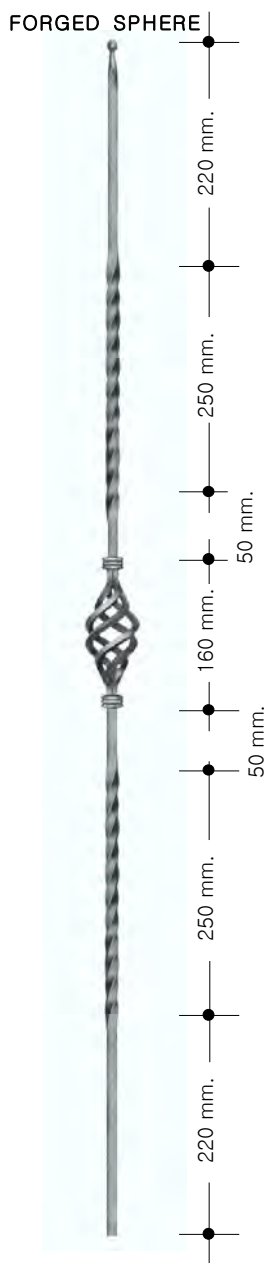

P-4105/B TW
 1.410 kg.-3.107 lbs.
 Dim.55 x 1200 mm.
 2"3/16 x 47"2/8

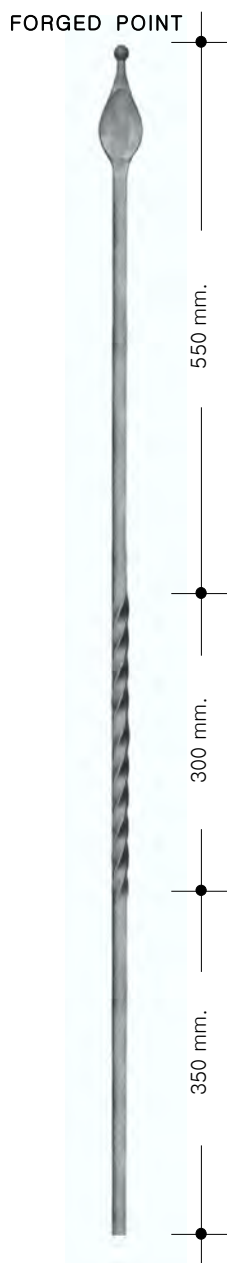

P-4305/A TW
 1.356 kg.-2.988 lbs.
 Dim.40 x 1200 mm.
 1"9/16 x 47"2/8

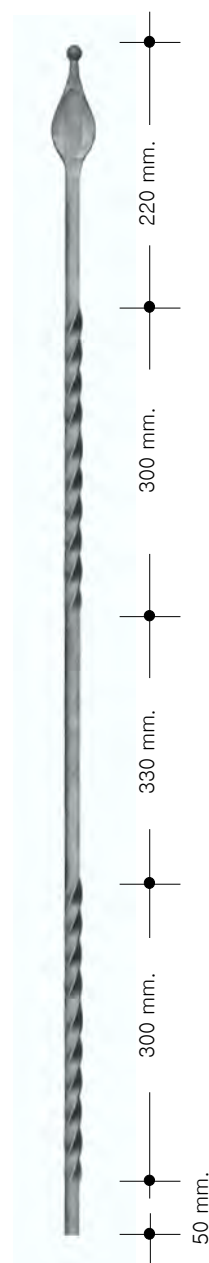

P-4305/B TW
 1.356 kg.-2.988 lbs.
 Dim.40 x 1200 mm.
 1"9/16 x 47"2/8

copy right reproduction prohibited

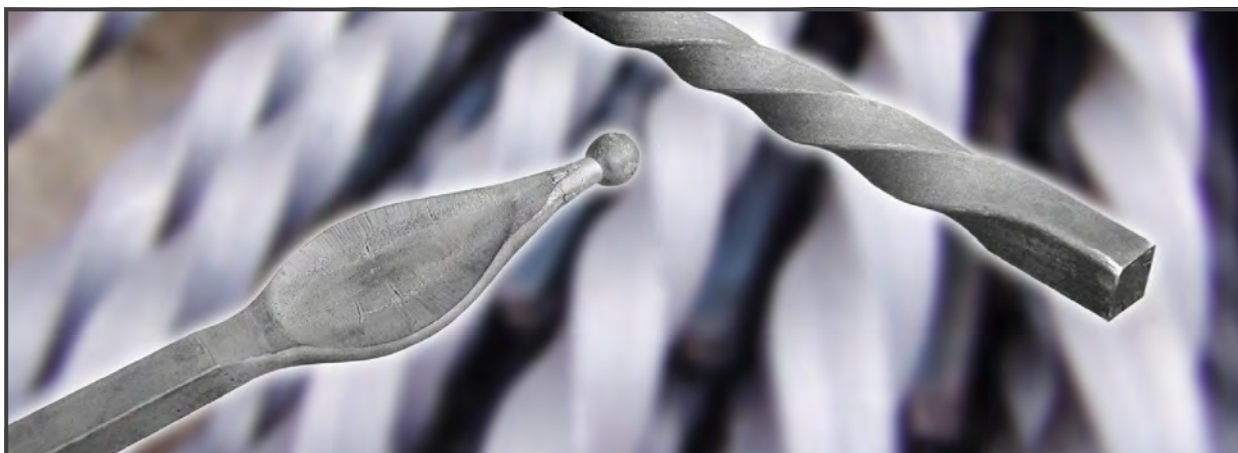



SERIE "P"

Assembled Pickets

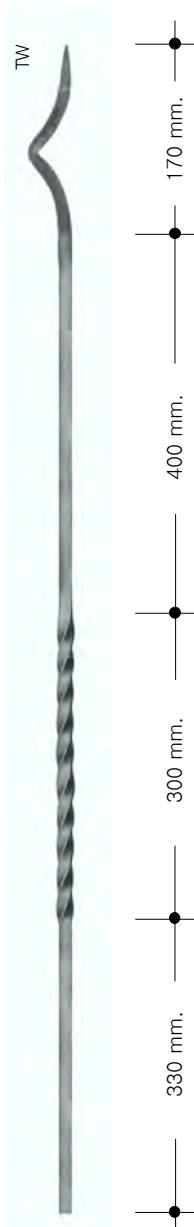

P-4205

1.356 kg.-2.988 lbs.
Dim.40 x 1200 mm.
1"5/8 x 47"2/8

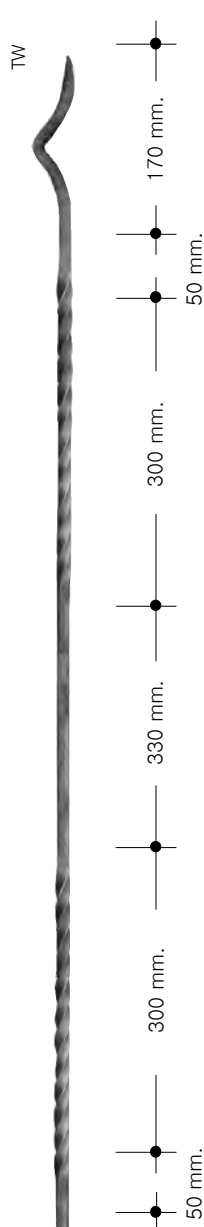

P-4205/A

1.356 kg.-2.988 lbs.
Dim.40 x 1200 mm.
1"5/8 x 47"2/8

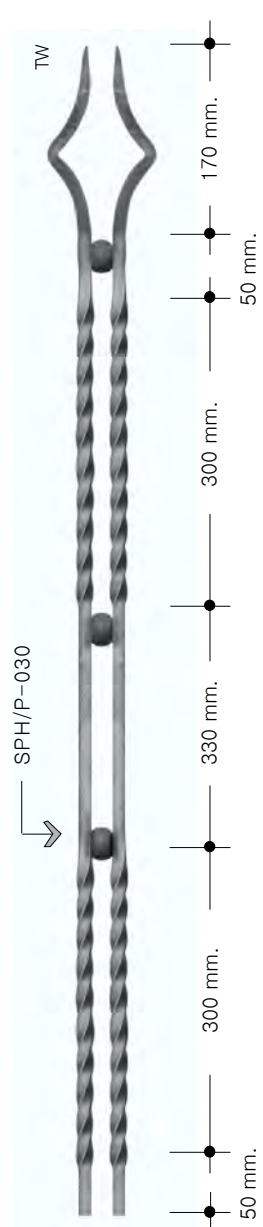

P-4205/D

3.050 kg.-6.722 lbs.
Dim.100 x 1200 mm.
1/2" x 3"15/16

copyright reproduction prohibited





SERIE "P"

Assembled Pickets

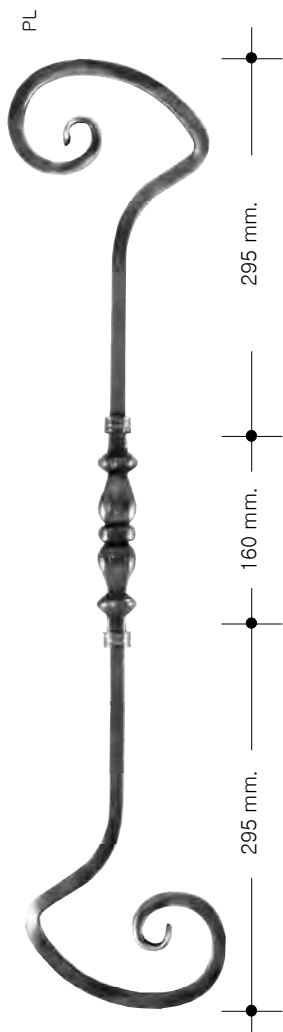

P-4505
 2.020 kg.-4.452 lbs.
 Dim.150 x 750 mm.
 5"7/8 x 29"4/8 Inch.

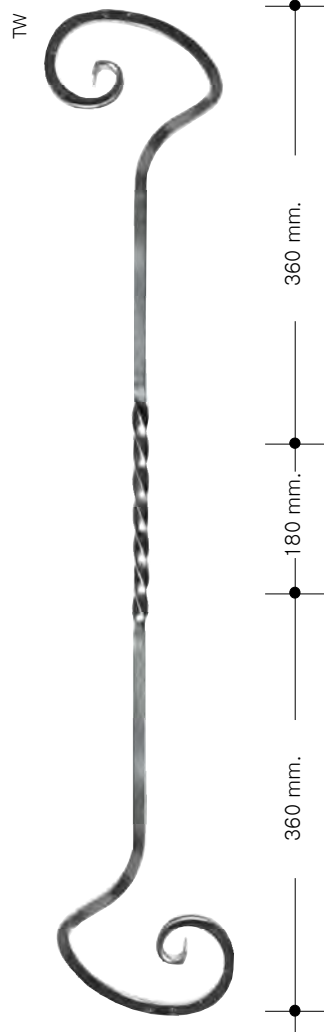

P-4401/D TW
 1.420 kg.-3.130 lbs.
 Dim.130 x 800 mm.
 5"1/8 x 31"4/8

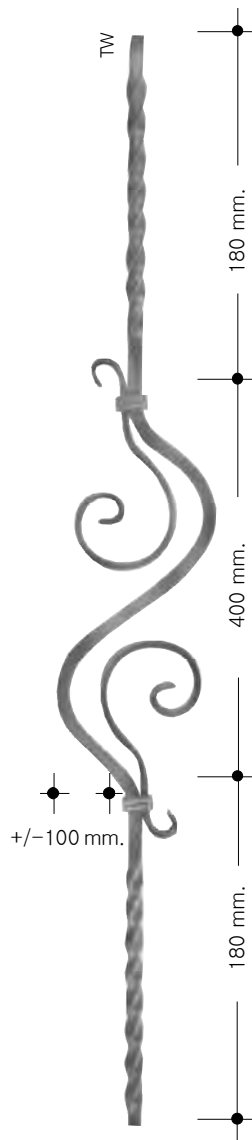

P-4901 TW
 1.620 kg.-3.570 lbs.
 Dim.150 x 900 mm.
 5"7/8 x 35"7/16

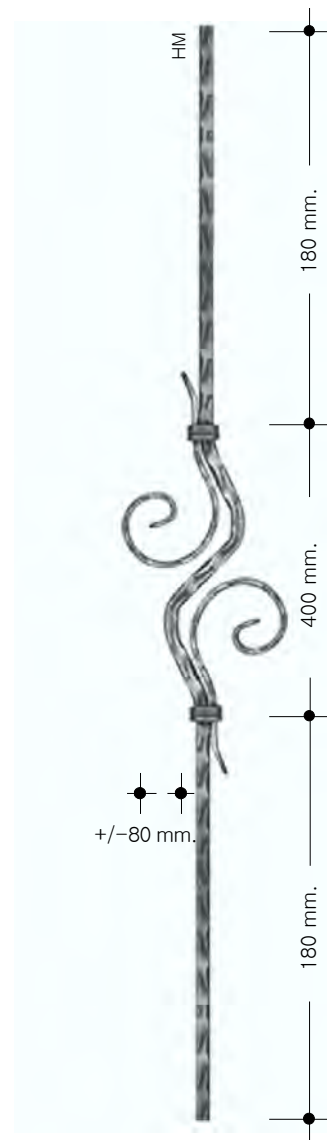

P-4901/A HM
 1.600 kg.-3.526 lbs.
 Dim.150 x 900 mm.
 5"7/8 x 35"7/16

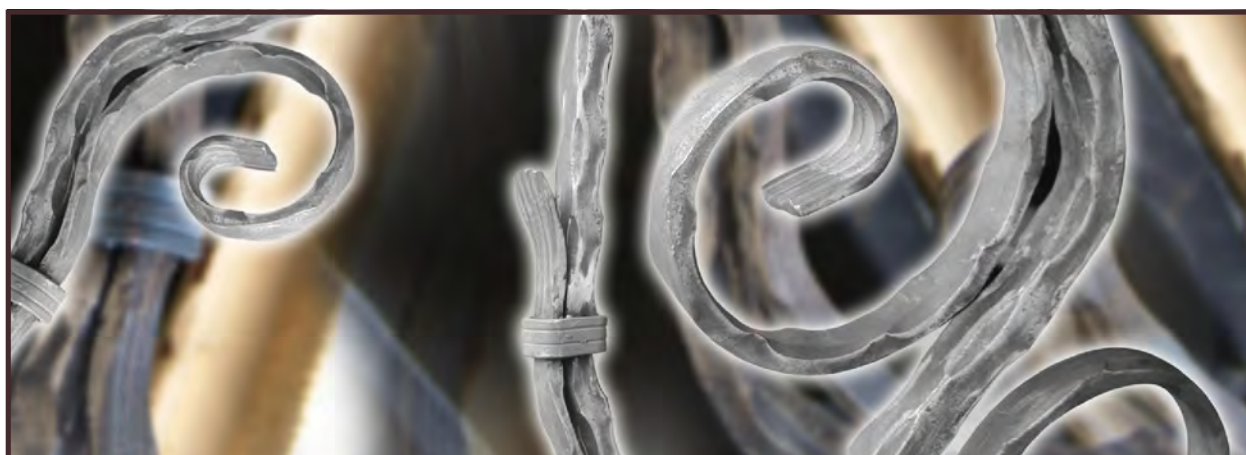



SERIE "P"

Assembled Pickets

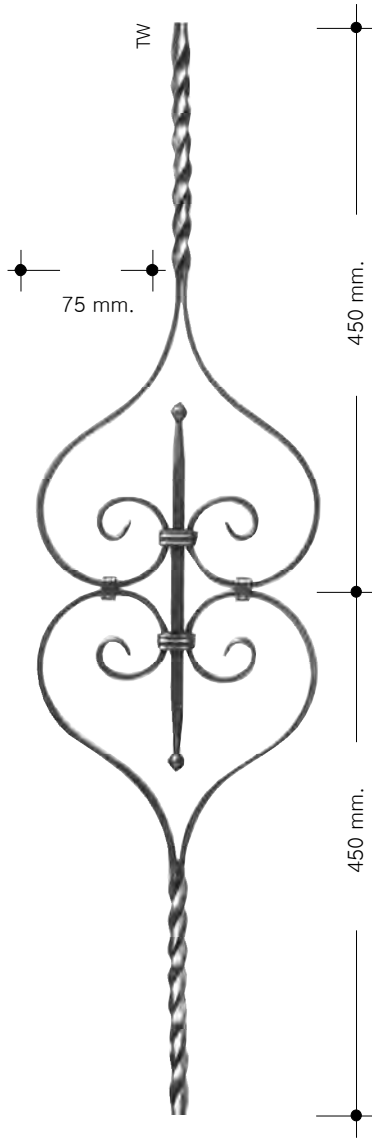

P-5001/D
2.030 kg.-4.474 lbs.
Dim.160 x 900 mm.
2"5/16 x 35"7/16

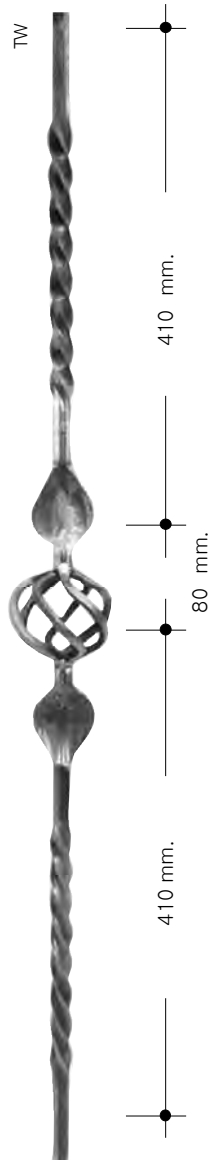

P-7305
1.126 kg.-2.481 lbs.
Dim.80 x 900 mm.
3"1/8 x 35"7/16



P-7305/A
1.295 kg.-2.854 lbs.
Dim.80 x 900 mm.
3"1/8 x 35"7/16

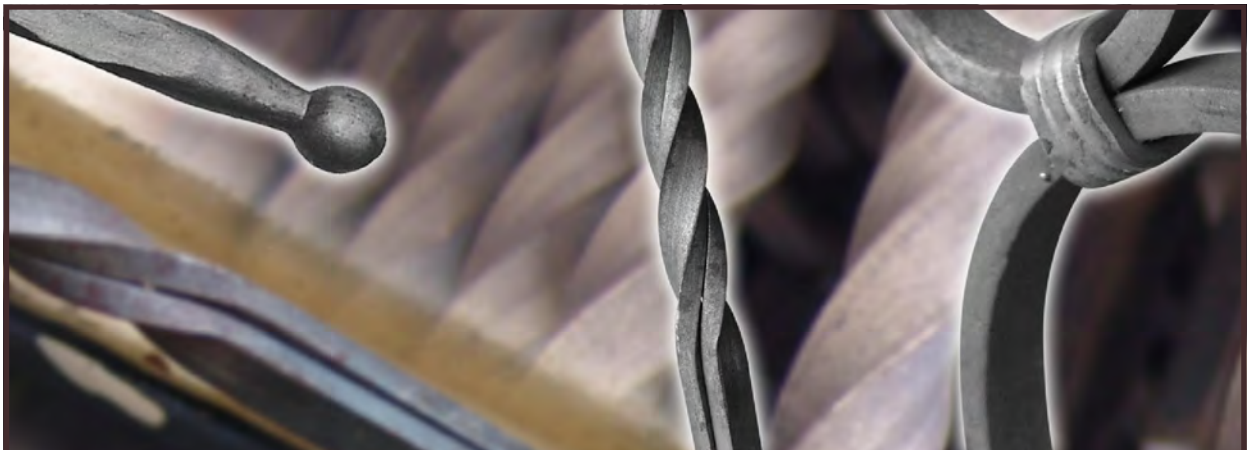



SERIE "P"

Bellies

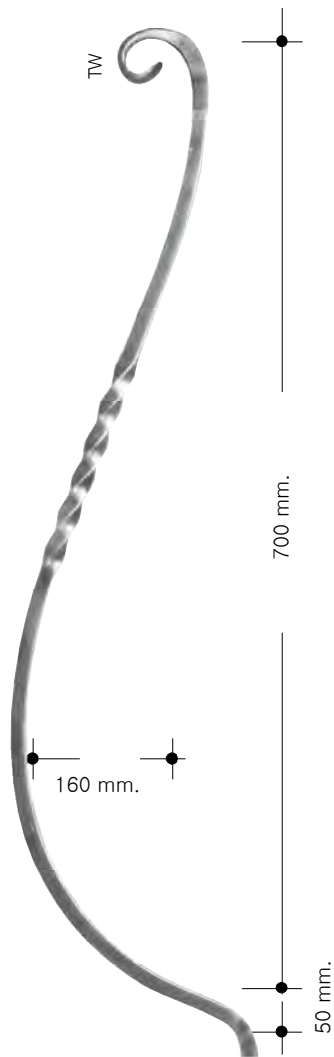

P-5105
1.045 kg.-2.303 lbs.
Dim.160 x 750 mm.
2"5/16 x 29"4/8

Belly shape for Balconies



Components fabricated by
PAS Classic Steel co.,Ltd Bangkok



P-5105/A
1.270 kg.-2.799 lbs.
Dim.160 x 750 mm.
2"5/16 x 29"4/8



Balconies at Sukhumvit rd.Bangkok
PAS Classic Steel co.,Ltd Bangkok

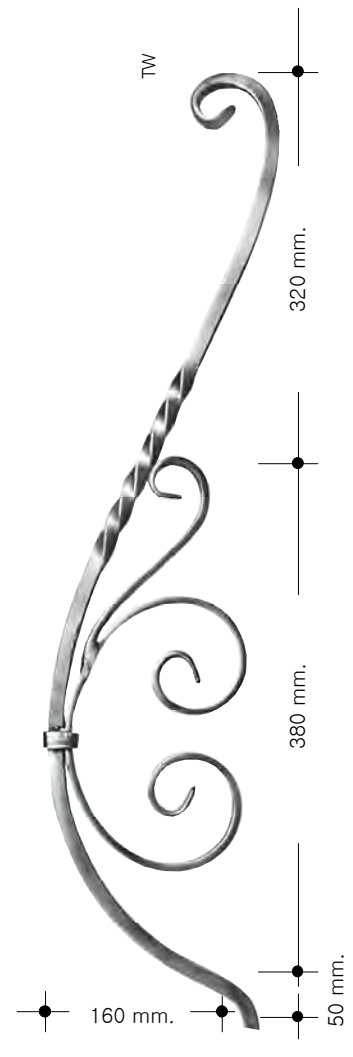

P-5105/B
1.560 kg.-3.438 lbs.
Dim.160 x 750 mm.
2"5/16 x 29"4/8
Panel for last right and last left

copy right reproduction prohibited



Assembled Posts

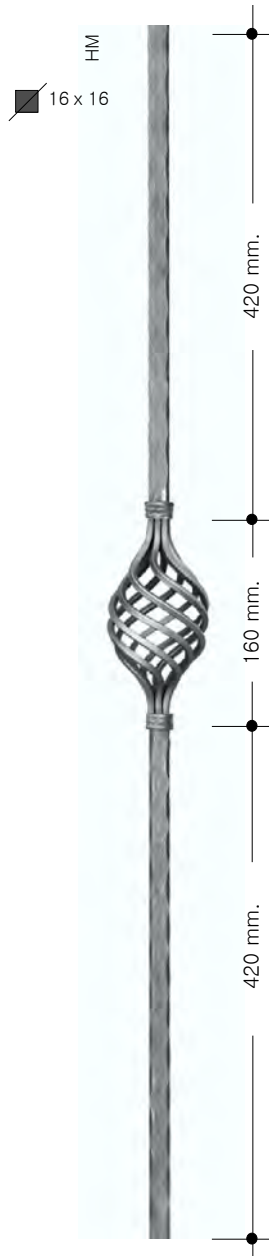

P-9117

2.260 kg.-4.981 lbs.
Dim.68 x 1000 mm.
2"11/16 x 39"3/8

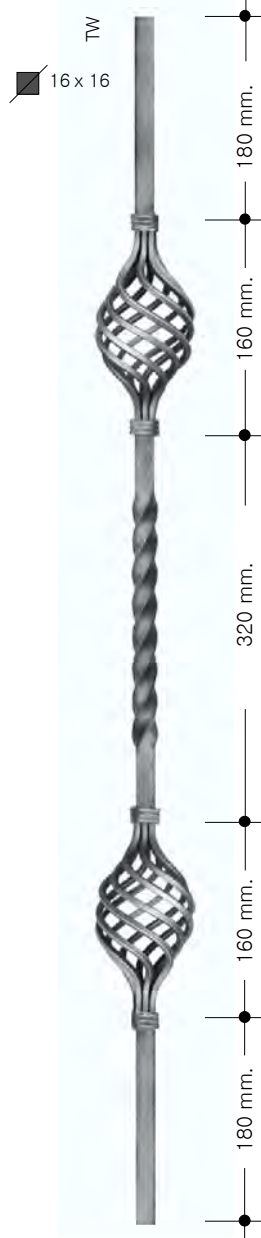

P-9218

2.310 kg.-5.091 lbs.
Dim.68 x 1000mm.
2"11/16 x 39"3/8

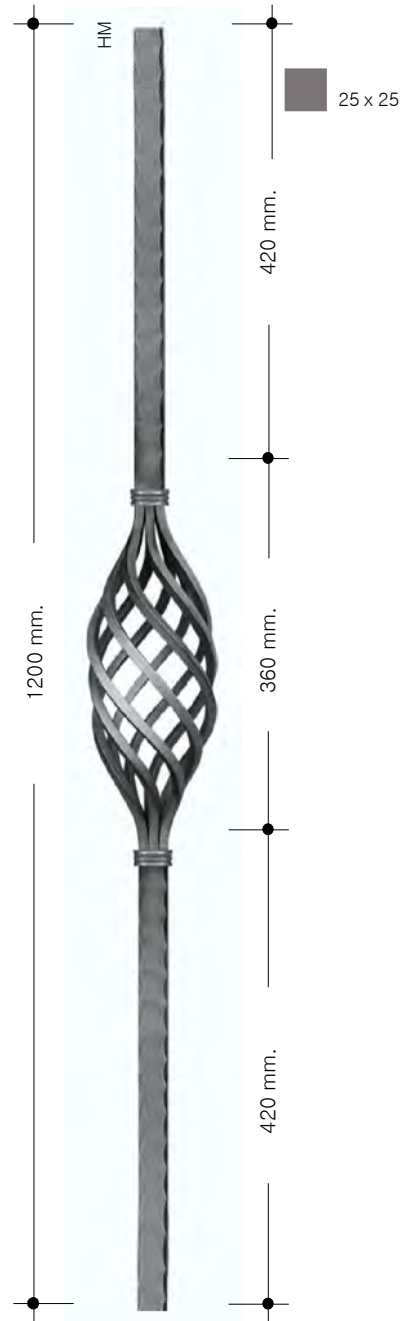

P-9329

6.750 kg.-14.87 lbs.
Dim.120 x 1200mm.
4"6/8 x 47"2/8

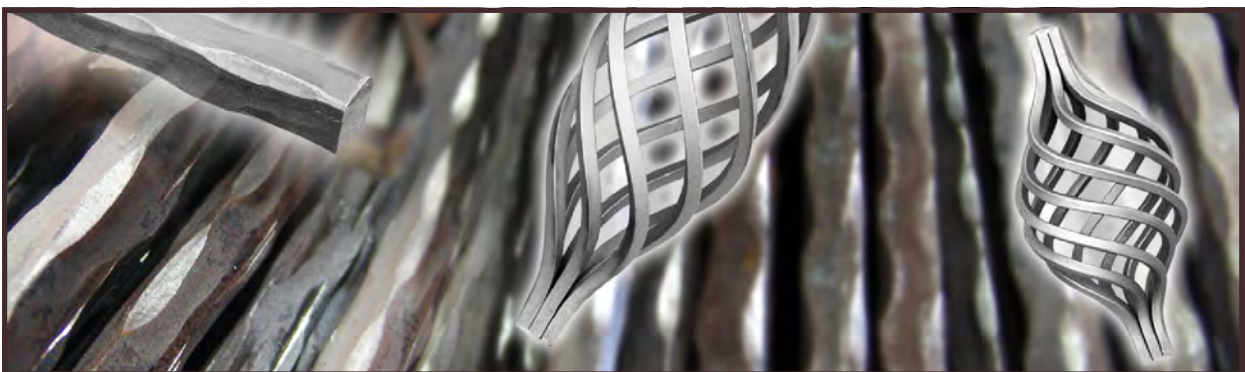



SERIE "P"

Bellies

PANELS & ACCESSORIES FOR FLOWER BED

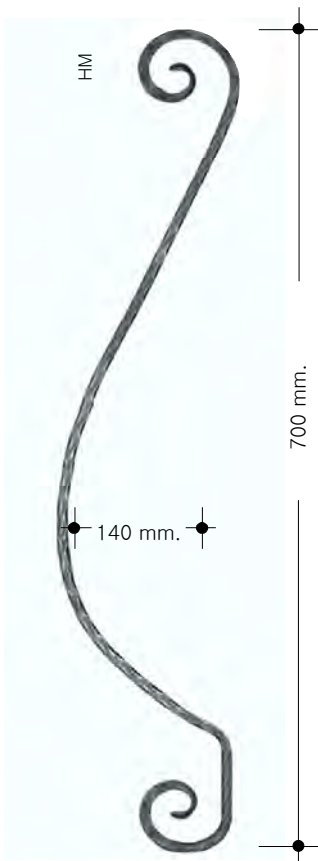

P-5105/C
1.045 kg.-2.303 lbs.
Dim.160 x 750 mm.
2"5/16 x 29"4/8

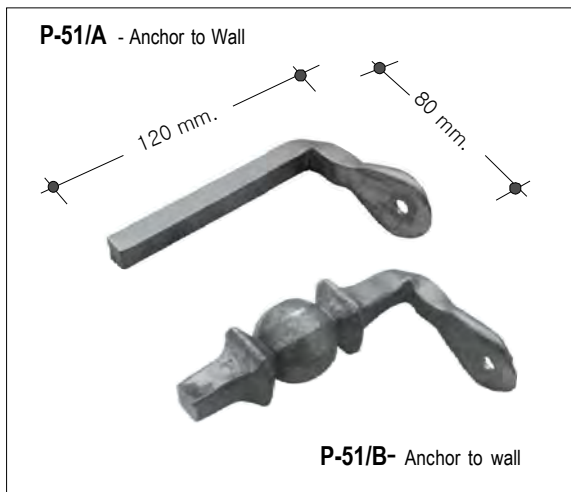

P-51/A - Anchor to Wall

P-51/B- Anchor to wall

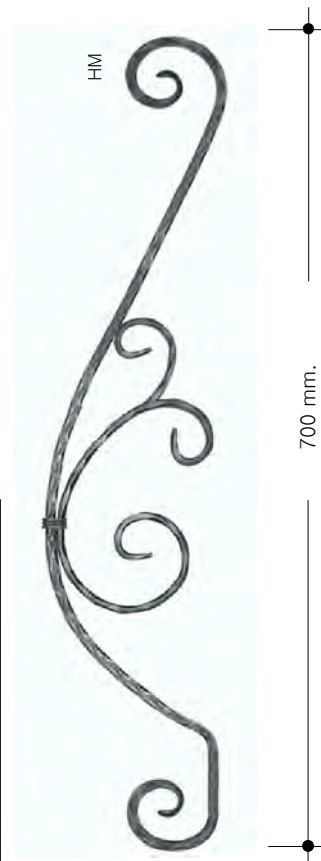

P-5105/D
1.045 kg.-2.303 lbs.
Dim.160 x 750 mm.
2"5/16 x 29"4/8
Panel for Last Left and Lat Right

SKETCH DETAIL ASSEMBLY

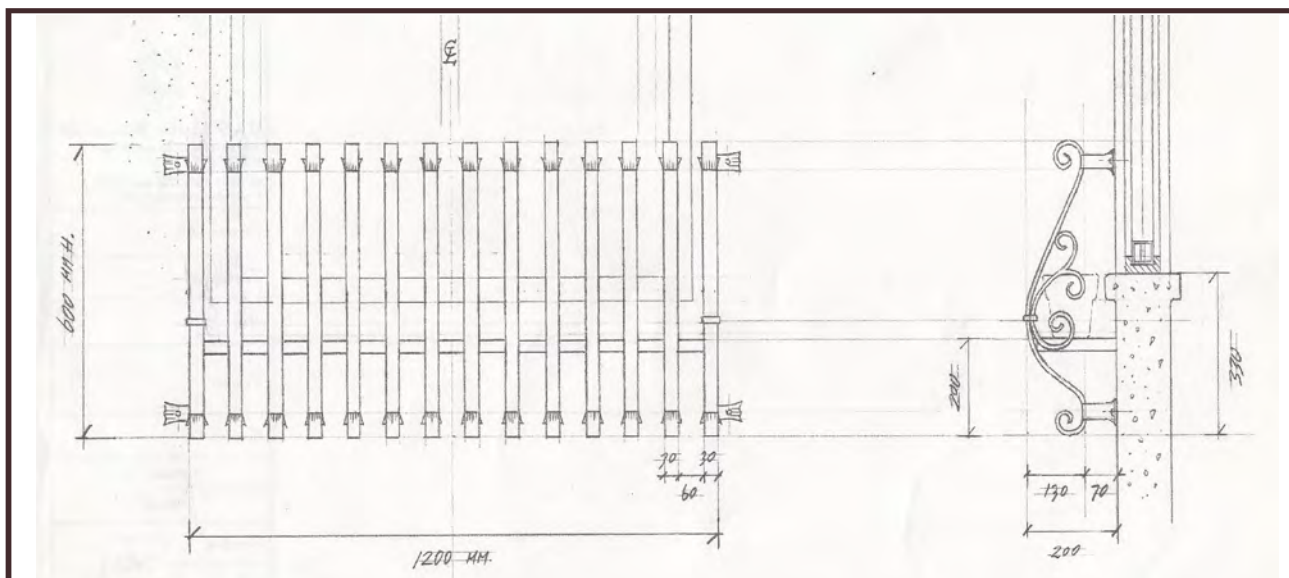

copy right reproduction prohibited